

AIR CURTAINS



FOR COMMERCIAL AND
INDUSTRIAL APPLICATIONS



SOLUTIONS IN VENTILATION

Since the company was incorporated in 1983, SODECA has focused its business activity on designing and manufacturing industrial fans, ventilation systems and smoke extract fans.

SODECA fans and extractor systems undergo the most stringent quality procedures certified by BUREAU VERITAS, in accordance with 9001:2015. The quality of the product as well as the research and development methods used have made it possible for SODECA to become one of the most renowned fan manufacturers in the world.

Among other aspects, one of our most important values is being customer service oriented, which is why we have outstanding professionals assigned to assist you in offering the best fan solution adapted to the requirements of each project.

SODECA's main installations have a surface area of more than 15,000 m² and are located in Ripoll, a town near Barcelona. The building was built in 2018 and has been recognised for its energy management system. Among other aspects, the installations are equipped with a hermetically designed automated shutter system to improve energy efficiency.

We offer you the possibility of visiting our installations where you can see the fan manufacturing process, with the highest quality requirements, while we protect our environment by investing in energy efficiency.





Our environmental commitment

SODECA presents efficient fans with high performance EC TECHNOLOGY motors equipped with state of the art technology to obtain higher energy savings. These products exceed the requirements of the ErP 2009/125/EC Ecodesign Directive and its regulating provisions (EU) 327/2011 for fans, collaborating with the EU KYOTO Protocol objective of reducing carbon emissions.

By simply replacing the fan you currently have installed with a fan fitted with EC technology will allow you to obtain electricity consumption savings of 21%.

Energy savings enable the excess cost of the EC equipment to be quickly amortised. It is a profitable option, with or without a demand control ventilation system.



AIR CURTAINS

COMMERCIAL AND INDUSTRIAL

EFFICIENCY WITHOUT COMPROMISING

Air curtains can **reduce the consumption of air-conditioning in a premises up to 30%**, avoiding draughts and thermal gradients that affect comfort and well-being.

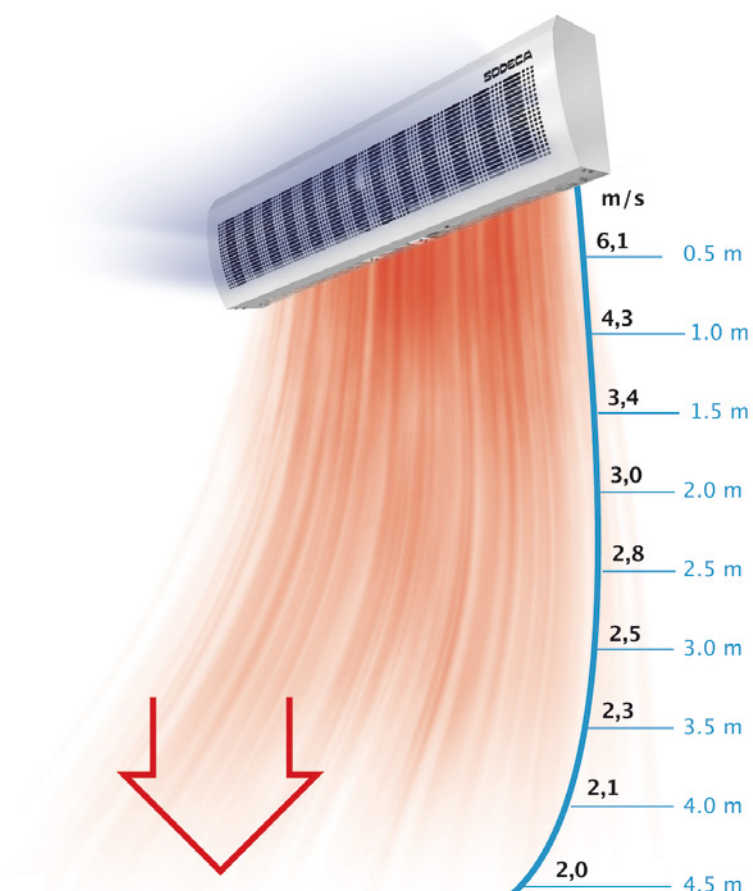

EFFICIENT DESIGNS

Efficient designs that achieve adjustable laminar flows with a greater scope and minimum consumption of electricity.

A WIDE VARIETY OF APPLICATIONS

Large variety of curtains for a multitude of applications, doorway sizes and assembly possibilities.

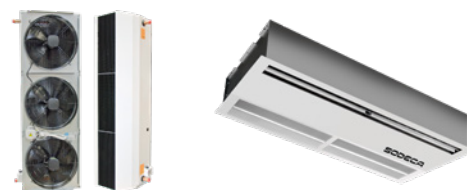



INNOVATIVE DESIGN

Curtains that perfectly combine innovation and design.

NUMEROUS CONTROL POSSIBILITIES

Most curtains can be controlled in a variety of ways thus covering a diverse range of needs.



TYPES OF AIR CURTAINS

The air curtains can be used just to recirculate the indoor air or they can be used as heating in many premises:



Environmental

These use fans to recirculate the room air without adding heat.



Electrical

These recirculate the room air and, during the cold months, when necessary, they heat this air using electrical resistances.



Hot water

These recirculate the room air and, during the cold months, when necessary, they heat this air using hot water batteries.

The curtains that come with electrical or water battery heating can be used as a source of heating, as their output and volume of hot air can heat a surface area of between 500 and 750 m², depending on the model, in the area surrounding the door.

SELECTING AND INSTALLING AIR CURTAINS

- 1 Decide which series of air curtains most interests you based on doorway height and preferred design
- 2 Choose the ideal model based on the width of the doorway, the curtain should cover the entire doorway area with an extra 100 mm overlapping on each side
- 3 Select the type of curtain desired: the environmental, electrical or hot water model
- 4 Select the air curtain that best suits your needs to obtain a suitable sound level
- 5 Install the curtain as close as possible to the entrance on the inside of the premises
- 6 In the case of separate premises requiring a great deal of refrigeration, install the curtain on the warmer side

To ensure the air curtain works as well as possible, it is advisable to install and operate this using the especially designed controllers.

SELECTION CHART BY DOORWAY HEIGHT

Choose the series that best suits your project's needs based on doorway height.

The maximum doorway height specified in the graph is limited when the curtain's air speed reaches 2.1 m/second. With lower air speeds higher doorways are also possible.

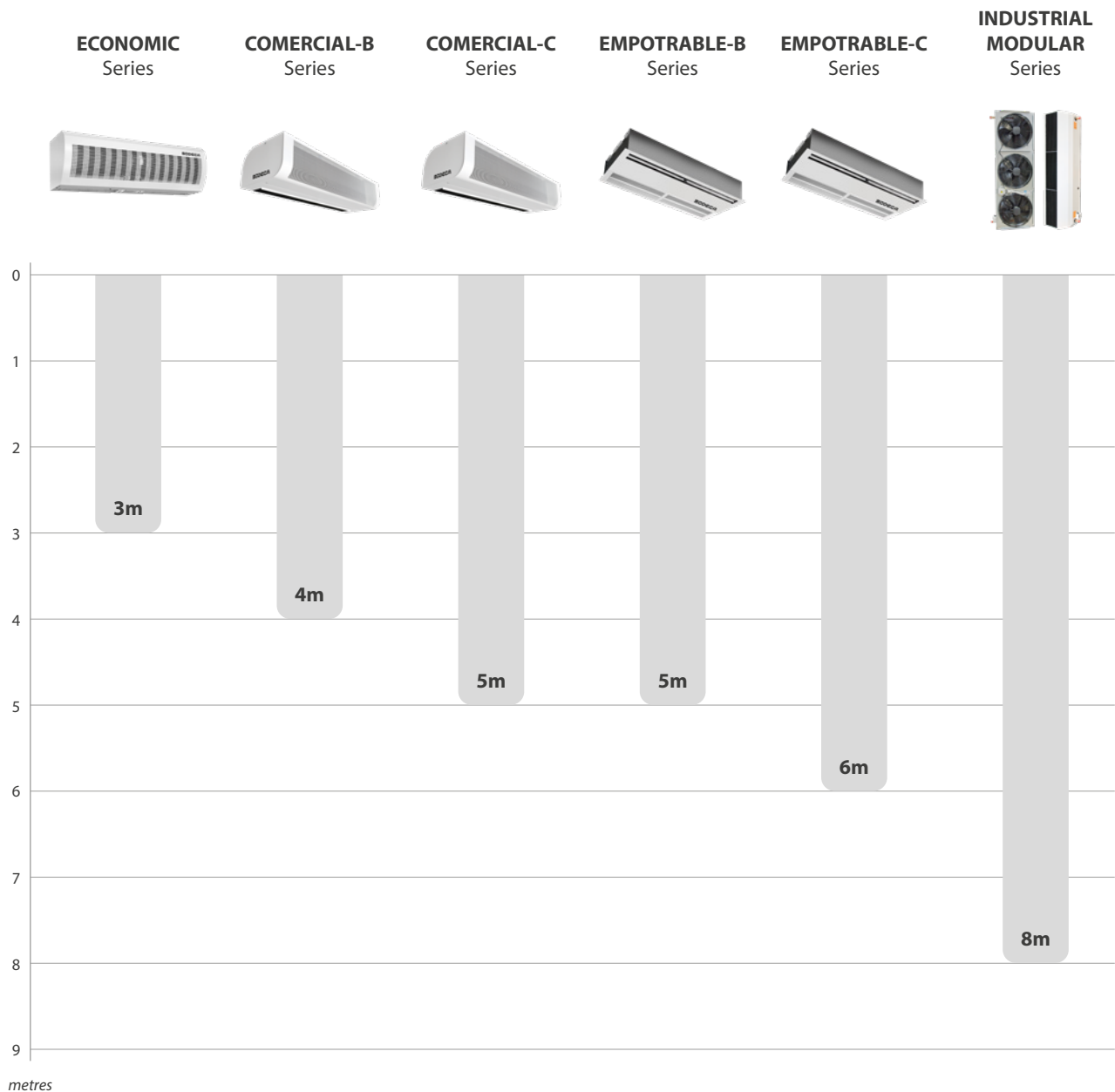

EXTERNAL CONTROLS FOR CURTAINS

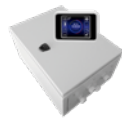

IC-C

Cabinet for the control of INDUSTRIAL MODULAR curtains, with support for heating batteries, interconnection of curtains, touch control interface and MODBUS.



IC-S

Cabinet for the control of INDUSTRIAL MODULAR curtains. Expands the number of shades controlled from an IC-C control. It only works in interconnection with an IC-C.



IC-M

Cabinet for the control of INDUSTRIAL MODULAR curtains, with support for heating batteries, interconnection of curtains and exclusive control through MODBUS.



STRA1

Cabinet for the control of INDUSTRIAL MODULAR curtains without heating batteries.



NTC-10K

Temperature probe for INDUSTRIAL MODULAR curtain.

INTERCONNECTION OF CURTAINS AND ELECTRICAL CIRCUIT DIAGRAMS

The interconnection of the curtains makes it possible to control several units using the same remote selector so that these all operate at the same time and in the same way.

Due to the range of the wireless selector the curtains that are linked wirelessly are limited in terms of the maximum number of units that can be interconnected.

If cable is used to link the curtains up to six units can be interconnected.

When cables are used to form the interconnections, choose one curtain as the main master curtain and connect this to the external control panel using the communication cable supplied. The rest of the curtains should be linked up using the KABEL accessory cable, indicating the necessary length.

The external control selector connected to the main curtain and to the external contacts will control all of the curtains at the same time.

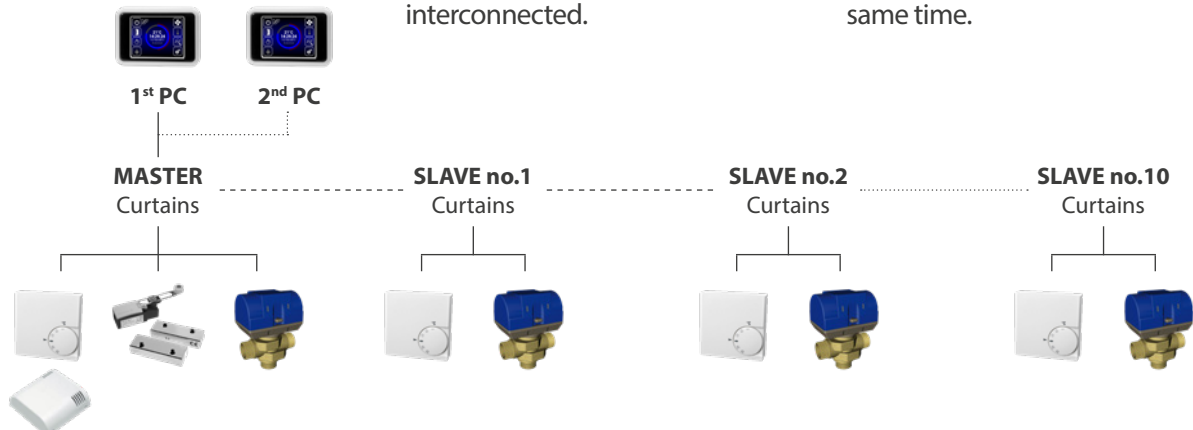

ASSEMBLY AND INSTALLATION

- The air curtain shall be assembled as close as possible to the upper edge of the doorway in the case of horizontal curtains and in the case of vertically assembled ones, as close as possible to the side edge of the doorway (see figure 1).
- To ensure these work correctly, the curtain should overlap approximately 100 mm each side of the doorway (see figure 2).
- The minimum recommended distance between the curtain and the ceiling is 50 mm.
- Any obstacle close to the curtain must be placed at a distance of at least 200 mm to ensure that this does not interfere with its operation.
- In the case of the electrical and water versions, remember to take into consideration the outlet side of the electrical connections and water from the batteries during assembly.
- Assembly can be carried out using support arms or using rods hanging from the ceiling (see the Accessories Section).

General installation diagram for the air curtains

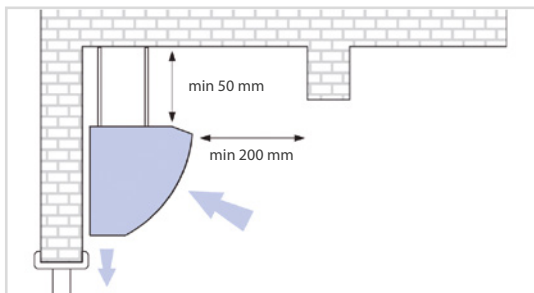

Figure 1

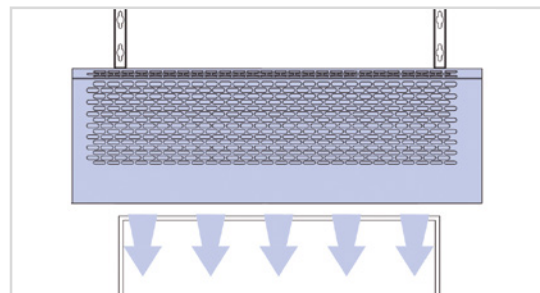

Figure 2

General installation diagram for the INDUSTRIAL MODULAR series air curtains

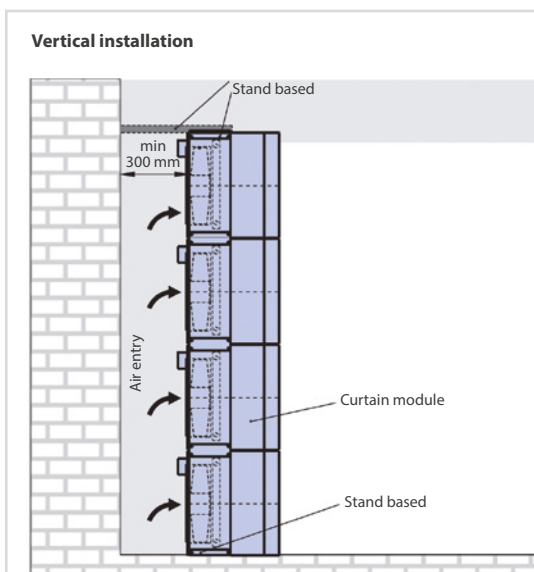

Figure 3

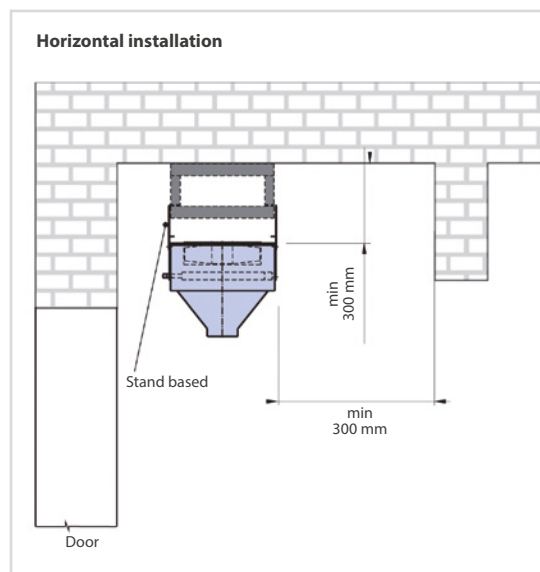

Figure 4

A BRIEF SUMMARY TO HELP YOU CHOOSE QUICKLY



Environmental



Electrical



By hot water



Horizontal assembly



Vertical assembly

Page 12

ECONOMIC series AC Model



External control
(Included in electrical version)

Height Door max.	Assembly	Use	Model	Length (mm)	Colour
3	←	🌿 ⚡	AC-09	900	RAL 9016
3	←	🌿 ⚡	AC-10	1000	RAL 9016
3	←	🌿 ⚡	AC-15	1500	RAL 9016
3	←	🌿 ⚡	AC-20	2000	RAL 9016

Page 13

COMERCIAL series COM Model



BASIC



COMFORT

Height Door max.	Assembly	Use	Model	Length (mm)	Colour
4	←	🌿 ⚡ 💧	COM-B-100	1190	RAL 9016
4	←	🌿 ⚡ 💧	COM-B-150	1600	RAL 9016
4	←	🌿 ⚡ 💧	COM-B-200	2100	RAL 9016
4	←	🌿 ⚡ 💧	COM-B-250	2510	RAL 9016
5	←	🌿 ⚡ 💧	COM-C-100	1190	RAL 9016
5	←	🌿 ⚡ 💧	COM-C-150	1600	RAL 9016
5	←	🌿 ⚡ 💧	COM-C-200	2100	RAL 9016
5	←	🌿 ⚡ 💧	COM-C-250	2510	RAL 9016

EMPOTRABLE series EMP Model



BASIC



COMFORT

Height Door max.	Assembly	Use	Model	Length (mm)	Colour
5	←	🌀 ⚡ 💧	EMP-B-100	1167	RAL 9016
5	←	🌀 ⚡ 💧	EMP-B-100	1667	RAL 9016
5	←	🌀 ⚡ 💧	EMP-B-200	2167	RAL 9016
5	←	🌀 ⚡ 💧	EMP-B-250	2547	RAL 9016
6	←	🌀 ⚡ 💧	EMP-C-100	1167	RAL 9016
6	←	🌀 ⚡ 💧	EMP-C-150	1667	RAL 9016
6	←	🌀 ⚡ 💧	EMP-C-200	2167	RAL 9016
6	←	🌀 ⚡ 💧	EMP-C-250	2547	RAL 9016

INDUSTRIAL MODULAR series IND Model



STRA1 control



IC controls

Height Door max.	Assembly	Use	Model	Length (mm)	Colour
7.5	↑ ←	🌀 ⚡ 💧	IND-150	1650	RAL 9016
8	↑ ←	🌀 ⚡ 💧	IND-200	2200	RAL 9016
7.5	↑ ←	🌀 ⚡ 💧	IND-250	2750	RAL 9016
7.5	↑ ←	🌀 ⚡ 💧	IND-150	1650	Galvanized
8	↑ ←	🌀 ⚡ 💧	IND-200	2200	Galvanized
7.5	↑ ←	🌀 ⚡ 💧	IND-250	2750	Galvanized

ECONOMIC

Economic air curtains for small commercial premises

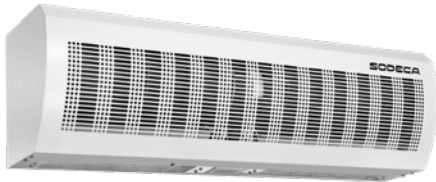

CONTROL
Version E



CONTROL
Version S

Economic air curtains for heights up to 3 m, for horizontal installation, specially designed for small commercial spaces.

Construction:

- Painted metal structure.
- Design for horizontal installation.
- Version S: Two speed fan.
- Led indicator of operation.
- Brackets for wall mounting.
- Version E: Electric coil control with safety elements. Delayed fan stop to evacuate residual heat.

Version:

- Ambiental: Air recirculation.
- Electrical: Incorporates electrical resistances.

External control:

- Version E: Control with remote control.

Application:

- Small commercial premises
- Shops
- Bars
- Offices

Order code

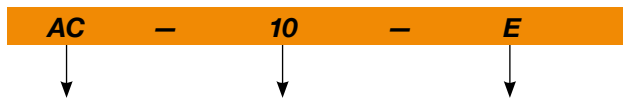

ECONOMIC: Economic air curtains for small commercial premises

09: Length 90 cm
10: Length 100 cm
15: Length 150 cm
20: Length 200 cm

S: Environmental
E: 230V or 400V
Electrical
depending on model

Control:

Operation

Speeds

Electrical battery control

Contact door

Led operating indicator



Ambiental



Electrical

manual

manual

2 speeds

1 speed

no

1 power level

no

no

yes

yes

Technical characteristics

Model	Height door (m)	Maximum airflow (m ³ /h)	Irradiated NPS dB (A)	Heat power (kW)	Battery voltage (V)	Battery current (A)	Fan voltage (V)	Fan current (A)	Weight (Kg)
AC-09-S	3	1200	43	-	-	-	1x230	0.65	15
AC-10-S	3	1350	44	-	-	-	1x230	0.72	16
AC-15-S	3	2100	46	-	-	-	1x230	0.95	24
AC-09-E	3	1000	45	3.5	1x230	15	1x230	0.65	18
AC-10-E	3	1150	46	4.0	1x230	19	1x230	0.72	20
AC-15-E	3	1800	47	5.5	3X400	9	1x230	0.95	31
AC-20-E	3	2400	51	10.0	3X400	16	1x230	1.38	39

Dimensions mm

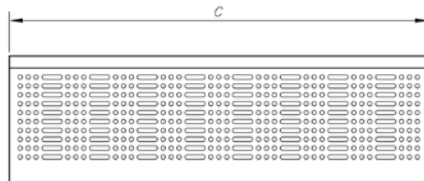
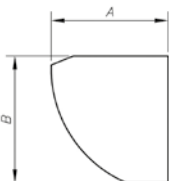

	A	B	C
AC-09-S	200	215	900
AC-10-S	200	215	1000
AC-15-S	200	215	1500
AC-09-E	195	220	900
AC-10-E	195	220	1000
AC-15-E	195	220	1500
AC-20-E	195	220	2000

COMERCIAL

Air curtains for commercial doors



BASIC



COMFORT

Perfect combination between innovation and design, offering a perfect and silent air curtain with impulsion through an adjustable diffuser, to obtain an optimal air direction.

Construction:

- Metal structure painted in RAL-9016 polyester.
- Widths of 1, 1.5, 2 and 2.5 m.
- Horizontal installation.
- Brackets for wall mounting included.
- Outlet grill with adjustable inclination.
- COM-B: door height up to 4 metres.
- COM-C: door height up to 5 metres.

Fan:

- 3 speed for flow rate adjustment.

Battery version:

- S: Environmental. Air recirculation.
- E: Electric. Control of the electric battery with up to 2 stages.
- V: Water. Hot water batteries.

Control version:

- Manual selector for wall installation.
- COMFORT-MASTER control: advanced digital selector for wall installation.

On request:

- Air curtains with COMFORT "SLAVE" control only to interconnect a maximum of 10 "SLAVE" curtains to a "MASTER" main curtain.

Control options

Control type	BASIC	BASIC	BASIC	COMFORT	COMFORT	COMFORT
Battery type	S	V	E	S	V	E
Electric battery control accessory	-	-	TER-P	-	-	TER-P
Water battery control accessory	-	TER-P + 3-way valve	-	-	TER-P + 3-way valve	-
Door contact control accessory	DS	DS	DS	DS / DK-1 / DK-B-3	DS / DK-1 / DK-B-3	DS / DK-1 / DK-B-3
External control voltage free contact	Door contact	Door contact	Door contact	Dedicated contact	Dedicated contact	Dedicated contact
Alarm contact	-	-	-	YES	YES	YES
Programmer	SH-TM-848	SH-TM-848	SH-TM-848	Integrated	Integrated	Integrated
Battery overheating protection	-	-	YES	-	-	YES
Interconnection curtains	-	-	-	Max. 11 units	Max. 11 units	Max. 11 units
MODBUS RTU communication	OE-M-AC3 accessory	OE-M-AC3 accessory	OE-M-AC3 accessory	YES	YES	YES
Remote control connection	Max. power cable 100 meters			UTP cable 4 wires max. 40 meters		
Possibility of additional control	-	-	-	YES	YES	YES
Power cables	2 + ground	2 + ground	4 + ground	2 + ground	2 + ground	4 + ground

Order code

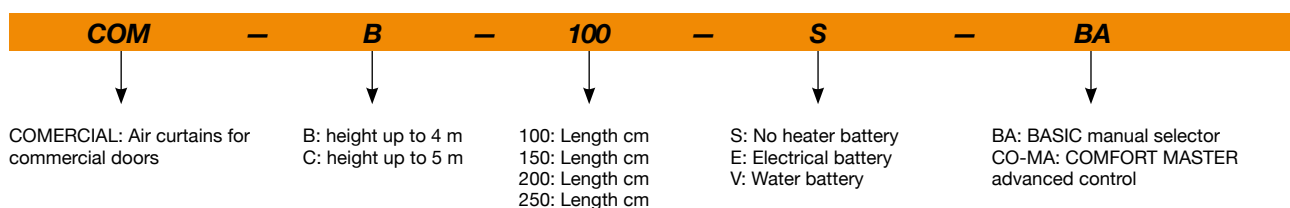

Technical characteristics

Model	Height door	Maximum airflow	LpA 5m Q=2	Power equipment	Equipment consumption	Motor consumption	Heater power (kW)		Increase temperature	Weight
	(m)	(m ³ /h)	dB (A)	(V) - (HZ)	(kW) / (l)	(W) / (l)	1st stage	Max.	(°C)	(Kg)
COM-B-100-S	4	1500	54	1x230 - 50/60	0.2 / 0.7	200 / 0.7	-	-	-	25
COM-B-150-S	4	2250	55	1x230 - 50/60	0.2 / 1.0	200 / 1.0	-	-	-	31
COM-B-200-S	4	3300	57	1x230 - 50/60	0.3 / 1.3	300 / 1.3	-	-	-	38
COM-B-250-S	4	3800	59	1x230 - 50/60	0.4 / 1.6	400 / 1.6	-	-	-	45
COM-B-100-E	4	1500	54	3x400 - 50/60	6.5 / 13.8	160 / 0.7	3.2	6.3	13.2	26
COM-B-150-E	4	2250	55	3x400 - 50/60	10.2 / 21.8	230 / 1.0	5.0	10.0	13.3	33
COM-B-200-E	4	3300	57	3x400 - 50/60	13.0 / 27.5	300 / 1.3	6.3	12.6	12.0	40
COM-B-250-E	4	3800	59	3x400 - 50/60	16.6 / 26.2	370 / 1.6	8.2	16.3	13.1	47
COM-B-100-V	4	1500	54	1x230 - 50/60	0.2 / 0.7	200 / 0.7	-	16.9	33.7	26
COM-B-150-V	4	2250	55	1x230 - 50/60	0.2 / 1.0	200 / 1.0	-	24.7	32.9	33
COM-B-200-V	4	3300	57	1x230 - 50/60	0.3 / 1.3	300 / 1.3	-	35.7	32.5	40
COM-B-250-V	4	3800	59	1x230 - 50/60	0.4 / 1.6	400 / 1.6	-	43.3	34.2	47
COM-C-100-S	5	2300	65	1x230 - 50	0.4 / 1.6	370 / 1.6	-	-	-	26
COM-C-150-S	5	3200	65	1x230 - 50	0.5 / 2.0	460 / 2.0	-	-	-	36
COM-C-200-S	5	4500	64	1x230 - 50	0.7 / 3.0	690 / 3.0	-	-	-	46
COM-C-250-S	5	5700	64	1x230 - 50	0.7 / 3.2	740 / 3.2	-	-	-	53
COM-C-100-E	5	2300	65	3x400 - 50	9.9 / 15.4	365 / 1.6	4.7	9.5	12.3	27
COM-C-150-E	5	3200	65	3x400 - 50	15.5 / 23.8	460 / 2.0	7.5	15.0	14.0	37
COM-C-200-E	5	4500	64	3x400 - 50	19.7 / 30.7	690 / 3.0	9.5	19.0	12.6	48
COM-C-250-E	5	5700	64	3x400 - 50	25.2 / 38.7	735 / 3.2	12.2	24.5	12.8	56
COM-C-100-V	5	2300	65	1x230 - 50	0.4 / 1.6	370 / 1.6	-	22.4	29.2	28
COM-C-150-V	5	3200	65	1x230 - 50	0.5 / 2.0	460 / 2.0	-	31.8	29.8	39
COM-C-200-V	5	4500	64	1x230 - 50	0.7 / 3.0	690 / 3.0	-	44.4	29.6	48
COM-C-250-V	5	5700	64	1x230 - 50	0.7 / 3.2	740 / 3.2	-	53.7	28.3	55

Water battery technical characteristics and 3-way valves accessories

Model	Airflow ref. (m ³ /h)	Temperature gradient 80/60 °C				Temperature gradient 60/40 °C				3-way valve accessory
		Heat power (kW)	Outlet temperature (°C)*	Loss of load (kPa)	Water level (l/s)	Heat power (kW)	Outlet temperature (°C)*	Loss of load (kPa)	Water level (l/s)	
COM-B-100-V	1500	14.1	46.2	10.3	0.2	8.3	34.5	4.1	0.1	ZV-3
COM-B-150-V	2250	20.6	45.4	7.3	0.3	11.9	33.8	2.8	0.5	ZV-3
COM-B-200-V	3300	29.8	45.1	10.6	0.4	17.3	33.7	4.0	0.8	ZV-3
COM-B-250-V	3800	36.2	46.6	16.7	0.4	21.3	34.8	6.5	0.9	ZV-3
COM-C-100-V	2300	18.6	42.2	17.0	0.2	10.7	32.0	6.6	0.5	ZV-3
COM-C-150-V	3200	26.4	42.7	11.5	0.3	15.0	32.0	4.2	0.7	ZV-3
COM-C-200-V	4500	36.9	42.6	15.8	0.5	21.1	32.0	5.8	0.9	ZV-3
COM-C-250-V	5700	44.8	41.6	24.7	0.6	26.0	31.7	9.4	1.1	ZV-3

* Air inlet temperature: +18 °C, at maximum heating and fan speed.

Air speed and range

Model	0 m	1 m	2 m	3 m	4 m	5 m
COM-B	9.1 m/s	5.5 m/s	3.7 m/s	3.2 m/s	2.5 m/s	-
COM-C	10.5 m/s	6.7 m/s	4.8 m/s	3.8 m/s	3.2 m/s	2.5 m/s

Dimensions mm

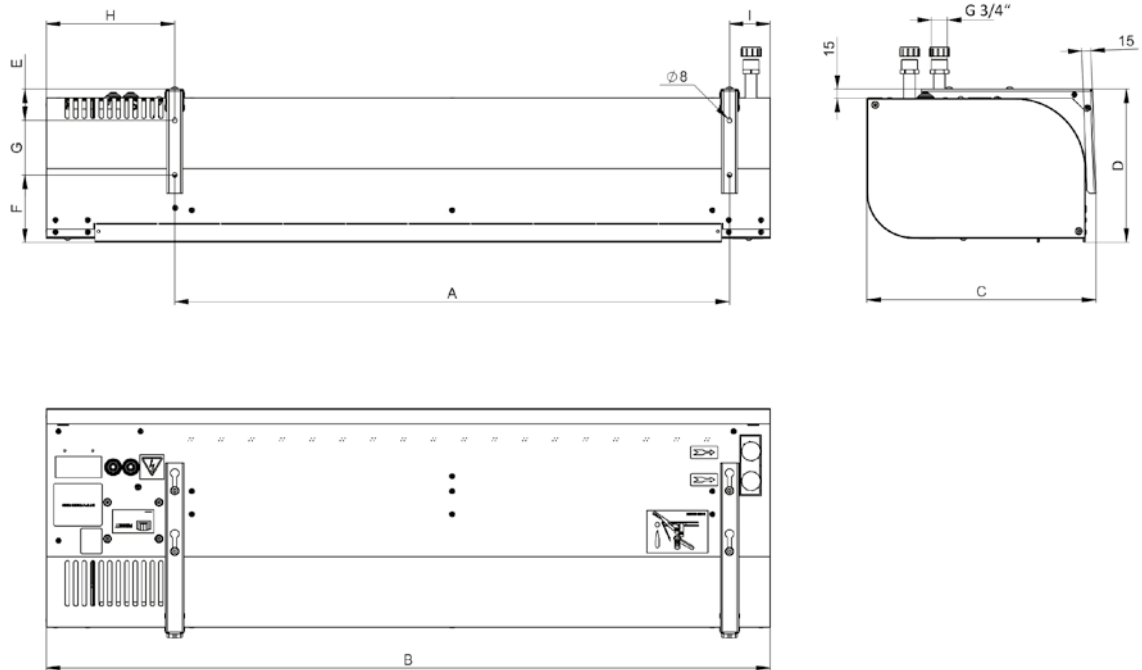

	A	B	C	D	E	F	G	H	I
COM-100	913	1190	377	252	51	111	90	211	67
COM-150	1321	1600	377	252	51	111	90	211	67
COM-200	1822	2100	377	252	51	111	90	211	67
COM-250	2232	2510	377	252	51	111	90	211	67

Accessories



CONTACTO
PUERTAS



SH-TM-848



TER-P



ACCESORIOS
INDUSTRIAL
MODULAR



NTC-10K



ZV

EMPOTRABLE

Recessed air curtains for commercial doors up to 6 m high



BASIC



COMFORT

Special design for installing the air curtain in technical ceilings with an inlet impulsion grille that requires little maintenance.

Construction:

- Metal structure painted in RAL-9016 polyester.
- Widths of 1, 1.5, 2 and 2.5 m.
- Horizontal installation.
- Outlet grill with adjustable inclination.
- EMP-B: door height up to 5 meters.
- EMP-C: door height up to 6 meters.

Battery version:

- S: Environmental. Air recirculation.
- E: Electric. Control of the electric battery with up to 2 stages.
- V: Water. Hot water batteries. For a maximum temperature of 100 °C and 16 bar pressure.

Fan:

- 3 speed for flow rate adjustment.

Control version:

- BASIC: manual selector for wall installation.

On request:

- Air curtains with COMFORT "SLAVE" control only to interconnect a maximum of 10 "SLAVE" curtains to a "MASTER" main curtain.
- Brackets for wall mounting. Ref: VCS4-KONZ-STE.
- Brackets for ceiling mounting. Ref: VCS4-KONZ-STR.
- COMFORT-MASTER control: advanced digital selector for wall installation. On request.

Control options

Control type	BASIC	BASIC	BASIC	COMFORT	COMFORT	COMFORT
Battery type	S	V	E	S	V	E
Electric battery control accessory	-	-	TER-P	-	-	TER-P
Water battery control accessory	-	TER-P + 3-way valve	-	-	TER-P + 3-way valve	-
Door contact control accessory	DS	DS	DS	DS / DK-1 / DK-B-3	DS / DK-1 / DK-B-3	DS / DK-1 / DK-B-3
External control voltage free contact	Door contact	Door contact	Door contact	Dedicated contact	Dedicated contact	Dedicated contact
Alarm contact	-	-	-	YES	YES	YES
Programmer	SH-TM-848	SH-TM-848	SH-TM-848	Integrated	Integrated	Integrated
Battery overheating protection	-	-	YES	-	-	YES
Interconnection curtains	-	-	-	Max. 11 units	Max. 11 units	Max. 11 units
MODBUS RTU communication	OE-M-AC3 accessory	OE-M-AC3 accessory	OE-M-AC3 accessory	YES	YES	YES
Remote control connection	Max. power cable 100 meters			UTP cable 4 wires max. 40 meters		
Possibility of additional control	-	-	-	YES	YES	YES
Power cables	2 + ground	2 + ground	4 + ground	2 + ground	2 + ground	4 + ground

Order code

EMP	-	B	-	100	-	S	-	BA
↓		↓		↓		↓		↓
EMPOTRABLE: Recessed air curtains for commercial doors up to 6 m high		B: height up to 5 m C: height up to 6 m		100: Length cm 150: Length cm 200: Length cm 250: Length cm		S: No heater battery E: Electrical battery V: Water battery		BA: BASIC manual selector CO-MA: COMFORT MASTER advanced control

Technical characteristics

Model	Height door	Maximum airflow	LpA 3m Q=2	Power equipment	Equipment consumption	Engines consumption	Heater power (kW)		Increase temperature	Weight
	(m)	(m ³ /h)	dB (A)	(V) / (HZ)	(kW) / (l)	(W) / (l)	1st stage	Max.	(°C)	(Kg)
EMP-B-100-S	5	1793	58	1x230 / 50	0.6 / 2.8	630 / 2.8	-	-	-	38
EMP-B-150-S	5	2591	60	1x230 / 50	0.9 / 4.0	900 / 4.0	-	-	-	51
EMP-B-200-S	5	3476	62	1x230 / 50	1.2 / 5.3	1200 / 5.3	-	-	-	66
EMP-B-250-S	5	4313	63	1x230 / 50	1.5 / 6.5	1500 / 6.5	-	-	-	80
EMP-B-100-E	5	1778	58	3x400 / 50	10.1 / 16.3	630 / 2.8	4.6	9.4	15.7	40
EMP-B-150-E	5	2552	60	3x400 / 50	16.0 / 26.1	920 / 4.0	7.6	15.0	17.5	55
EMP-B-200-E	5	3444	61	3x400 / 50	20.5 / 32.4	1220 / 5.3	9.8	19.0	16.4	71
EMP-B-250-E	5	4187	63	3x400 / 50	26.1 / 42.2	1500 / 6.5	12.5	24.5	17.4	85
EMP-B-100-V	5	1691	58	1x230 / 50	0.6 / 2.75	630 / 2.8	-	24.8	36.2	41
EMP-B-150-V	5	2449	60	1x230 / 50	0.9 / 4.0	900 / 4.0	-	38.8	38.1	56
EMP-B-200-V	5	3391	61	1x230 / 50	1.2 / 5.3	1200 / 5.3	-	52.6	37.6	73
EMP-B-250-V	5	4061	63	1x230 / 50	1.5 / 6.5	1500 / 6.5	-	62.3	37.3	87
EMP-C-100-S	6	2517	62	1x230 / 50	1.1 / 4.8	1100 / 4.8	-	-	-	42
EMP-C-150-S	6	3468	63	1x230 / 50	1.5 / 6.3	1450 / 6.3	-	-	-	57
EMP-C-200-S	6	4393	64	1x230 / 50	1.9 / 7.9	1850 / 7.9	-	-	-	71
EMP-C-250-S	6	5084	66	1x230 / 50	2.3 / 9.7	2250 / 9.7	-	-	-	84
EMP-C-100-E	6	2467	61	3x400 / 50	11.0 / 18.8	1081 / 4.7	4.6	9.4	11.3	44
EMP-C-150-E	6	3401	63	3x400 / 50	16.5 / 28.3	1430 / 6.2	7.6	15.0	13.1	60
EMP-C-200-E	6	4318	64	3x400 / 50	20.8 / 35.4	1790 / 7.8	9.8	19.0	13.0	76
EMP-C-250-E	6	5018	66	3x400 / 50	26.7 / 45.2	2160 / 9.4	12.5	24.5	14.5	90
EMP-C-100-V	6	2334	61	1x230 / 50	1.1 / 4.7	1100 / 4.7	-	29.1	32.3	46
EMP-C-150-V	6	3251	63	1x230 / 50	1.5 / 6.2	1450 / 6.2	-	44.6	34.6	61
EMP-C-200-V	6	4226	64	1x230 / 50	1.8 / 7.8	1800 / 7.8	-	57.0	34.8	77
EMP-C-250-V	6	4885	66	1x230 / 50	2.2 / 9.4	2200 / 9.4	-	67.3	35.0	92

Water battery technical characteristics and 3-way valves accessories

Model	Airflow ref. (m ³ /h)	Thread connection	Temperature gradient 80/60 °C				Temperature gradient 60/40 °C				3-way valve accessory
			Heat power (kW)	Outlet temperature (°C)*	Loss of load (kPa)	Water level (l/s)	Heat power (kW)	Outlet temperature (°C)*	Loss of load (kPa)	Water level (l/s)	
EMP-B-100-V	1691	G ¾"	16.8	47.7	8	0.2	9.3	34.4	4	0.1	ZV-3
EMP-B-150-V	2449	G ¾"	25.9	49.5	16	0.3	14.9	36.1	8	0.7	ZV-3
EMP-B-200-V	3391	G ¾"	35.1	49.0	13	0.4	20.0	35.7	6	0.2	ZV-3
EMP-B-250-V	4061	G ¾"	41.8	48.7	10	0.5	23.7	35.4	5	0.3	ZV-3
EMP-C-100-V	2334	G ¾"	20.6	44.4	9	0.3	11.3	32.5	4	0.1	ZV-3
EMP-C-150-V	3251	G ¾"	31.1	46.5	22	0.4	17.7	34.3	9	0.2	ZV-3
EMP-C-200-V	4226	G ¾"	40.6	46.7	15	0.5	23.0	34.3	7	0.3	ZV-3
EMP-C-250-V	4885	G ¾"	47.1	46.8	12	0.6	26.5	34.2	5	0.3	ZV-3

* Air inlet temperature: +18 °C, at maximum heating and fan speed.

Air speed and range

Model	0 m	1 m	2 m	3 m	4 m	5 m	6 m	7 m
EMP-B	7.7 m/s	4.8 m/s	3.5 m/s	3.0 m/s	2.5 m/s	2.2 m/s	2.0 m/s	-
EMP-C	10.1 m/s	6.3 m/s	4.7 m/s	3.9 m/s	3.3 m/s	3.0 m/s	2.6 m/s	2.3 m/s

Dimensions mm

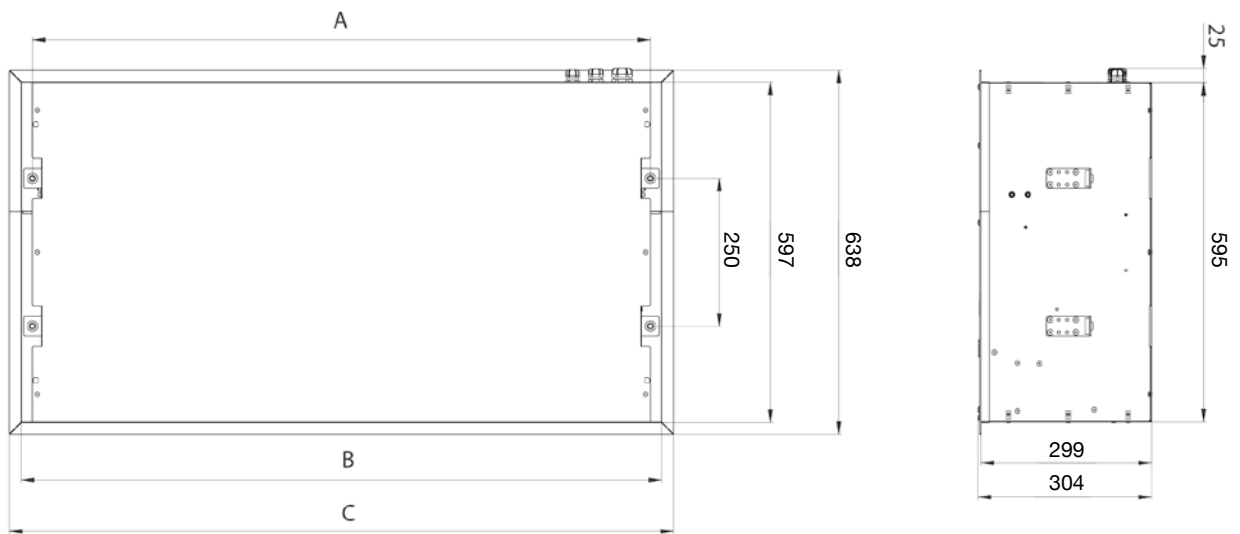

	A	B	C
EMP-100	1085	1125	1167
EMP-150	1585	1625	1667
EMP-200	2085	2125	2167
EMP-250	2465	2505	2547

Accessories



VCS4-KONZ-STE

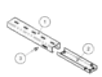

VCS4-KONZ-STR



CONTACTO
PUERTAS



SH-TM-848



TER-P



ACCESORIOS
INDUSTRIAL
MODULAR



NTC-10K



ZV

INDUSTRIAL MODULAR

Modular construction air curtains for installation on industrial doors up to 8 m high and up to 12 m wide



STRA1 control

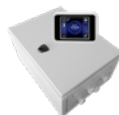

IC controls

Robust construction with modular design, to be able to adjust the curtain to the size of the door. IP54 protection in all models except version with electric coil (IP20). Covers up to 12 m wide door, installing curtains on both sides. The equipment works without special controls. The controls add additional functions.

Construction:

- Galvanized steel frame painted in RAL 9016 polyester.
- Design for vertical or horizontal installation.
- 1,65 m module with 3 fans.
- 2,2 m module with 4 fans.
- 2,75 m module with 5 fans.

Version in accordance with heating options:

- S0: Environmental. Air recirculation.
- E1: Electrical. Incorporates electrical resistances.
- V2: By water. It incorporates water batteries up to 110 °C.
- P2: By water. Incorporates water batteries up to 110 °C with antifreeze.

Order code

IND	-	100	-	S0	-	0
↓		↓		↓		↓
INDUSTRIAL MODULAR: Modular construction air curtains for installation on industrial doors up to 8 m high and up to 12 m wide		150: Length 165 cm 200: Length 220 cm 250: Length 275 cm		S0: No heater battery E1: Electrical battery V2: Water battery 100 °C P2: Water battery 100 °C with antifreeze		0: White RAL 9016 1: Galvanized

Technical characteristics

Model	Height door (m)	Maximum airflow (m³/h)	NPS 5 m dB (A)	Heat power* (kW)	Battery voltage (V)	Battery consumption (l)	Motor voltage (V) - (HZ)	Motor consumption (W) / (l)	Weight (Kg)
IND-150-S0	7.5	11550	63	-	-	-	1x230 - 50/60	900 / 3.9	51
IND-150-E1	7.5	11550	63	24.3	3x400	39.1	1x230 - 50	900 / 3.9	55
IND-150-V2	7.5	10300	63	75.2	-	-	1x230 - 50/60	900 / 3.9	60
IND-150-P2	7.5	10300	63	75.2	-	-	1x230 - 50/60	900 / 3.9	60
IND-200-S0	8.0	15100	65	-	-	-	1x230 - 50/60	1200 / 5.1	69
IND-200-E1	8.0	15100	65	32.4	3x400	52.2	1x230 - 50	1200 / 5.1	74
IND-200-V2	8.0	13700	64	101.0	-	-	1x230 - 50/60	1200 / 5.4	78
IND-200-P2	8.0	13700	64	101.0	-	-	1x230 - 50/60	1200 / 5.4	78
IND-250-S0	7.5	18500	67	-	-	-	1x230 - 50/60	1400 / 6.5	83
IND-250-E1	7.5	18500	67	40.5	3x400	65.1	1x230 - 50	1400 / 6.5	89
IND-250-V2	7.5	17000	66	127.0	-	-	1x230 - 50/60	1400 / 6.7	98
IND-250-P2	7.5	17000	66	127.0	-	-	1x230 - 50/60	1400 / 6.7	98

* The heating powers of water batteries are taken with a 90/70 °C water circuit and air inlet at 15 °C.

Water battery technical characteristics with temperature gradient 80/60 °C

Model	Airflow ref. (m ³ /h)	Heat power (kW)	Outlet temperature (°C)	Water level (l/s)	Loss of load (kPa)
IND-150-V2	10300	62.9	34.1	0.76	18
IND-200-V2	13700	84.6	34.3	1.03	14
IND-250-V2	17000	106.0	34.5	1.29	11

Air inlets to +15 °C.

Water battery technical characteristics with temperature gradient 110/80 °C

Model	Airflow ref. (m ³ /h)	Heat power (kW)	Outlet temperature (°C)	Water level (l/s)	Loss of load (kPa)
IND-150-P2	10300	91.3	43.6	0.75	16
IND-200-P2	13700	123.0	43.9	1.0	12
IND-250-P2	17000	154.0	44.3	1.26	10

Air inlets to +15 °C.

Electrical battery technical characteristics

Model	Airflow ref. (m ³ /h)	Heat power (kW)	Increase temperature (°C)
IND-150-E1	11550	24.3	6.3
IND-200-E1	15100	32.4	6.4
IND-250-E1	18500	40.5	6.5

Control accessories



Contact box accessories for electric batteries

Accessory model	Finish	Courtain
IND-CAJA-BAT-E-25-0	White RAL 9016	1 u. for each module 150 or 200
IND-CAJA-BAT-E-25-1	Galvanized	
IND-CAJA-BAT-E-40-0	White RAL 9016	1 u. for each module 250
IND-CAJA-BAT-E-40-1	Galvanized	

Mounting accessories

Installation type	Mounting accessory	Finish	Number of units required
Horizontal installation bracket. Wall moorings.	IND-SOP-H-PARED-0	White RAL 9016	No. of modules + 1
	IND-SOP-H-PARED-1	Galvanized	
Horizontal installation bracket. Ceiling moorings.	IND-SOP-H-TECHO-0	White RAL 9016	No. of modules + 1
	IND-SOP-H-TECHO-1	Galvanized	
Fixed vertical installation bracket	IND-SOP-V-FIJA-0	White RAL 9016	1 for vertical column of modules
	IND-SOP-V-FIJA-1	Galvanized	
Adjustable vertical installation bracket	IND-SOP-V-AJUST-0	White RAL 9016	1 for vertical column of modules
	IND-SOP-V-AJUST-1	Galvanized	
		IND-SOP-V-AJUST-4M-0 IND-SOP-V-AJUST-4M-1	White RAL 9016 Galvanized

Dimensions mm

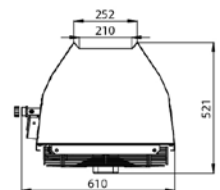
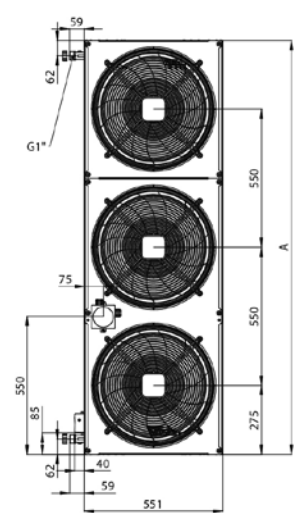
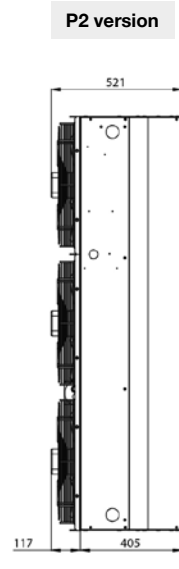
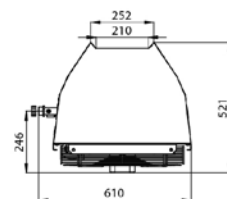
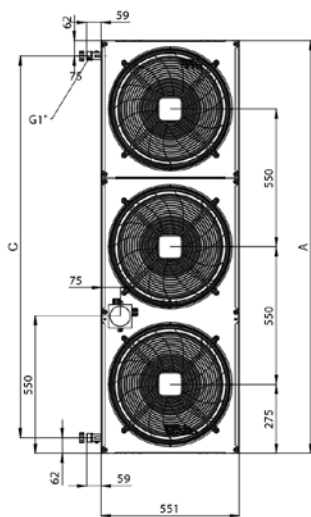
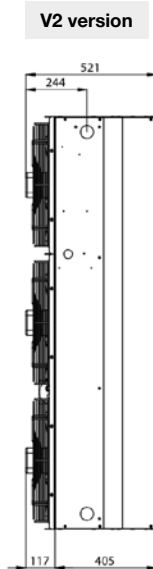
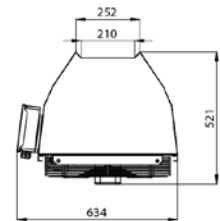
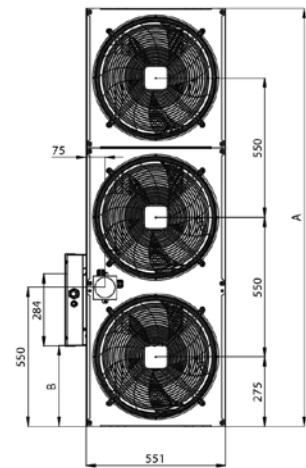
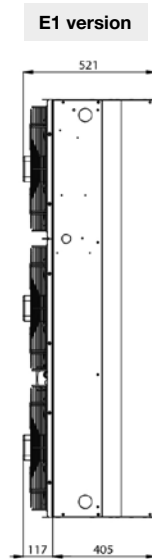
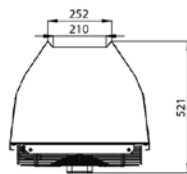
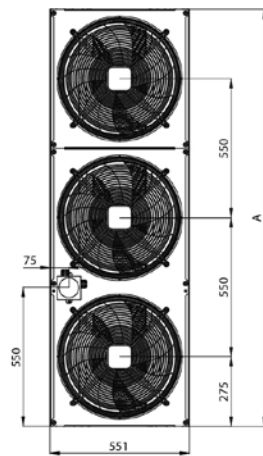
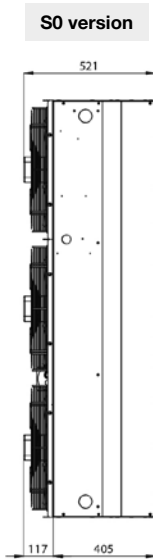

	A	B	C
IND-150	1650	320	1526
IND-200	2200	870	2076
IND-250	2750	870	2626

Technical characteristics controls

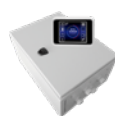

Optional controls (control - battery)

	STRA1	IC-C	IC-S	IC-M
Control type	Manual	Manual / Auto	Associated with IC-C	MODBUS RTU
Speeds	5	5	5	5
Control of batteries by air inlet / outlet of the curtain	-	Included	Included	Included
Control of batteries by means of air temperature sensor of the room	-	NTC-10K accessory	NTC-10K accessory	NTC-10K accessory
Battery control by room temperature thermostat	-	TER-P accessory	TER-P accessory	TER-P accessory
Power control of electric batteries	-	IND-CAJA-BAT-E. accessory	IND-CAJA-BAT-E. accessory	IND-CAJA-BAT-E. accessory
Electric battery regulation stages	-	2	2	2
On/Off regulation water battery valve	RT-3-15 + TER-P accessories	RT-3-15 accessory	RT-3-15 accessory	RT-3-15 accessory
0-100% regulation water battery valve	-	ZV-3-24V-12 accessory	ZV-3-24V-12 accessory	ZV-3-24V-12 accessory
Compatible with door contact	DK-1 or DS	DK-1 or DS	DK-1 or DS	DK-1 or DS
Contact for external control	NC/NO contact	YES	YES	YES
Built-in timer	-	YES	-	-
Maintenance indication	YES	YES	-	-
Open door indication	-	YES	-	-
Electrical battery cooling control	-	YES	YES	YES
Anti-frost control	-	YES	YES	-
Module interconnection	-	IC-S controls only	Needs 1 IC-C control	YES
Visual operating indicator	-	YES	-	-
Control panel lock	-	YES	-	-
MODBUS RTU connection	-	YES	YES	YES

Model	Power supply	IP protection	Max. current (A)	Dimensions mm AxBxC	Weight (Kg)
STRA1-075L22	1x230V 50/60Hz	IP54	7.5	200x305x155	8
STRA1-160L20	1x230V 50/60Hz	IP54	16.0	300x425x235	20
IC-C-AC5-04	1x230V 50/60Hz	IP66	4.0	423x300x211	14
IC-C-AC5-07	1x230V 50/60Hz	IP66	7.0	423x300x211	15
IC-C-AC5-16	1x230V 50/60Hz	IP66	16.0	423x300x211	23
IC-S-AC5-04	1x230V 50/60Hz	IP66	4.0	423x300x211	14
IC-S-AC5-07	1x230V 50/60Hz	IP66	7.0	423x300x211	15
IC-S-AC5-16	1x230V 50/60Hz	IP66	16.0	423x300x211	23
IC-M-AC5-04	1x230V 50/60Hz	IP65	4.0	423x300x211	14
IC-M-AC5-07	1x230V 50/60Hz	IP65	7.0	423x300x211	15
IC-M-AC5-16	1x230V 50/60Hz	IP65	16.0	423x300x211	23

CONTROL ACCESSORIES



CONTACTO PUERTAS

Door contacts

Contacts for external doors, to be connected to the curtain and to control its operation, depending on the position of the door.

- DS door contact.
- DK1 door contact.
- DK-B-3 door contact.



TER-P

Room thermostat

- Activates the air curtain, depending on the room temperature, it can be connected to the external contact of the air curtain.
- Depending on the model, this makes it possible to control the power level of the electrical or water batteries. See manuals for further information.
- Compatible with curtains that have external contacts.



SH-TM-848

Timer with weekly program

- It allows programming, throughout the week, the hours of operation of the curtains.
- It can be connected to the external contact of the air curtain.



KABEL

Communication cable

Cable for the connection between the curtain and the control panel or to interconnect the curtains with each other.

- KABEL-15M: 15 m length.
- KABEL-40M: 40 m length.

BRACKETS

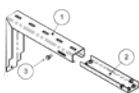

VCS4-KONZ-STE

Wall mount bracket

- Set of 2 brackets to easily mount the curtain on the wall.
- Compatible with EMPOTRABLE.

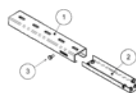

VCS4-KONZ-STR

Ceiling mount bracket

- Set of 2 brackets to easily mount the curtain on the wall.
- Compatible with EMPOTRABLE.

ACTUATORS TO CONTROL WATER BATTERIES



TV1

Thermostatic valve TV1-1/1

- It allows proportional control of the water temperature of the curtain coil. The valve will be installed in dry areas, where the ambient temperature is between +5 °C and +60 °C. The water control temperature will be between 0 °C and +90 °C, with a maximum pressure of 0.1 MPa.
- Compatible with all curtains with water batteries.



ZV

3-way thermostatic valve, with ZV-3 servomotor

- It allows proportional control of the water temperature of the curtain coil, by means of a 3 way valve and a servomotor. The valve will be installed in dry areas, where the ambient temperature is between +5 °C and +60 °C. The water control temperature will be between 0 °C and +110 °C, with a maximum pressure of 0.1 MPa.
- Compatible with all curtains with water batteries.



SMU

Mixed control system SMU

- This system provides energy savings by checking on and controlling the proportion of hot water in the curtain's coils' supply and return circuits and the temperature of the premises. This system can control several curtains simultaneously, provided that they are all of the same size and connected in parallel. It consists of two shut-off valves, a mixed valve with servo-actuator, two flexible tubes, two thermometers and a pump, to be installed in hot water pipes. Also includes an ambient sensor and a control panel.
- Compatible with INDUSTRIAL MODULAR.



MV3

Mixing valve with servo

- This system allows energy savings, controlling the proportion of hot water between the supply and return circuit of the curtain battery and the temperature of the premises. This system can control several air curtains at the same time, as long as all the air curtains are the same size and are connected in parallel. It incorporates a double valve with a servo-actuator.
- Compatible with COMERCIAL.



HEADQUARTER

Sodeca, S.L.U.
Pol. Ind. La Barricona
Carrer del Metall, 2
E-17500 Ripoll
Girona, SPAIN
Tel. +34 93 852 91 11
Fax: +34 93 852 90 42
General sales:
comercial@sodeca.com
Export sales:
ventilation@sodeca.com

PRODUCTION PLANT

Sodeca, S.L.U.
Ctra. de Berga, km 0,7
E-08580 Sant Quirze de
Besora
Barcelona, SPAIN
Tel. +34 93 852 91 11
Fax: +34 93 852 90 42
General sales:
comercial@sodeca.com
Export sales:
ventilation@sodeca.com



EUROPE

FINLAND
Sodeca Finland, Oy
HUITTINEN
Sales and Warehouse
Mr. Kai Yli-Sipilä
Metsälinnankatu 26
FI-32700 Huittinen
Tel. + 358 400 320 125
orders.finland@sodeca.com

HELSINKI
Smoke Control Solutions
Mr. Antti Kontkanen
Viilpulantie 9C
FI-00700 Helsinki
Tel. +358 400 237 434
akontkanen@sodeca.com

HYVINKÄÄ
Industrial Applications
Mr. Jaakko Tomperi
Niinistökatu 12
FI-05800 Hyvinkää
Tel. +358 451 651 333
jtomperi@sodeca.com

ITALIA
Marelli Ventilazione, S.R.L.
Viale del Lavoro, 28
37036 San Martino B.A.
(VR), ITALY
Tel. +39 045 87 80 140
vendite@sodeca.com

PORTUGAL
Sodeca Portugal, Unip. Lda.
PORTO
Rua Veloso Salgado 1120/1138
4450-801 Leça de Palmeira
Tel. +351 229 991 100
geral@sodeca.pt

LISBOA
Pq. Emp. da Granja Pav. 29
2625-607 Vialonga
Tel. +351 219 748 491
geral@sodeca.pt

ALGARVE
Rua da Alegria, 33
8200-569 Ferreiras
Tel. +351 289 092 586
geral@sodeca.pt

UNITED KINGDOM
Sodeca Fans UK, Ltd.
Mr. Mark Newcombe
Tamworth Enterprise Centre
Philip Dix House, Corporation
Street, Tamworth, B79 7DN
UNITED KINGDOM
Tel. +44 (0) 1827 216 109
sales@sodeca.co.uk

AMERICA

CHILE
Sodeca Ventiladores, SpA.
Sra. Sofía Ormazábal
Santa Bernardita 12.005
(Esquina con Puerta Sur)
Bodegas 24 a 26,
San Bernardo, Santiago, CHILE
Tel. +56 22 840 5582
ventas.chile@sodeca.com

COLOMBIA
Sodeca Latam, S.A.S.
Sra. Luisa Stella Prieto
Calle7 No. 13 A-44
Manzana 4 Lote1, Montaña
Mosquera, Cundinamarca
Bogotá, COLOMBIA
Tel. +57 1 756 4213
ventascolombia@sodeca.co

PERU
Sodeca Perú, S.A.C.
Sr. Jose Luis Jiménez
C/ Mariscal Jose Luis de
Orbegoso 331. Urb. El pino.
15022, San Luis. Lima, PERÚ
Tel. +51 1 326 24 24
Cel. +51 994671594
comercial@sodeca.pe



HEADQUARTER

Sodeca, S.L.U.
Pol. Ind. La Barricona
Carrer del Metall, 2
E-17500 Ripoll
Girona, SPAIN
Tel. +34 93 852 91 11
Fax: +34 93 852 90 42
General sales: comercial@sodeca.com
Export sales: ventilation@sodeca.com

PRODUCTION PLANT

Sodeca, S.L.U.
Ctra. de Berga, km 0,7
E-08580 Sant Quirze de Besora
Barcelona, SPAIN
Tel. +34 93 852 91 11
Fax: +34 93 852 90 42
General sales: comercial@sodeca.com
Export sales: ventilation@sodeca.com



www.sodeca.com

