

# HCH HCT

## Ventiladores helicoidales murales o tubulares, de gran robustez

Ventiladores helicoidales murales o tubulares, versión PL equipados con hélice de plástico y versión AL equipados con hélice de aluminio.

Ventilador:

- Dirección aire motor-hélice
- Hélices versión PL en poliamida 6 reforzada con fibra de vidrio y versión AL en fundición de aluminio. Los modelos HCT-40-2T y HCT-45-2T sólo en versión AL
- HCH: Aro soporte en chapa de acero
- HCT: Envoltente tubular en chapa de acero con caja de bornes exterior

Motor:

- Motores de eficiencia IE3 para potencias iguales o superiores a 0,75kW, excepto monofásicos, 2 velocidades y 8 polos.
- Motores clase F, con rodamientos a bolas, protección IP55, excepto modelos monofásicos desde el tamaño 45 hasta el tamaño 56, protección IP54. De 1 ó 2 velocidades según modelo
- Motor Multitensión, diseño especial válido para: 220/380V 60Hz, 254/440V 60Hz, 265/460V 60Hz, 277/480V 60Hz
- Temperatura de trabajo : -25°C.+ 50°C.

Acabado:

- Anticorrosivo en resina de poliéster polimerizada a 190 °C, previo desengrase con tratamiento nanotecnológico libre de fosfatos.

Bajo demanda:

- Dirección aire hélice-motor.
- Hélices reversibles 100%.
- Bobinados especiales para diferentes tensiones.
- Certificación ATEX Categoría 2



HCH



HCT

### Código de pedido

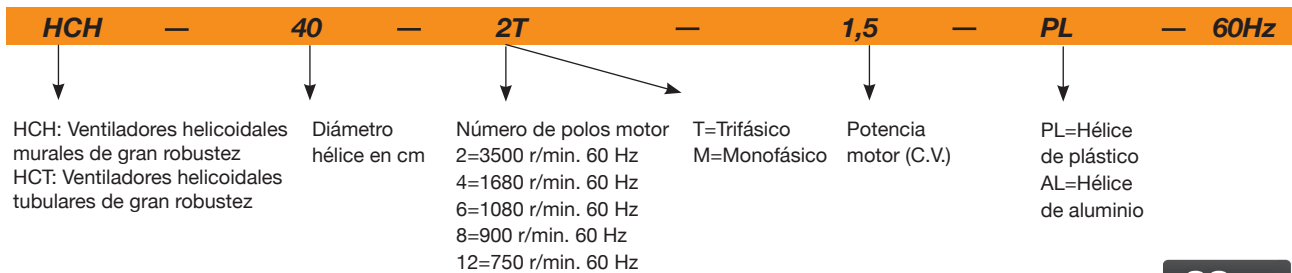

### Características técnicas

60Hz

Modelo	Velocidad (r/min)	Intensidad máxima admisible (A)		Potencia instalada (kW)	Caudal máximo (m³/h)	Nivel presión sonora dB(A)	Peso aprox.	
		220-277V	380-480V				HCH	HCT
HCT 25-2T	3204	0,64	0,37	0,09	1950	64		7
HCT 25-2M	3312	0,79		0,09	1950	64		7
HCT 25-4T	1584	0,65	0,38	0,09	1000	50		7
HCT 25-4M	1656	0,65		0,10	1000	50		7
HCT 31-2T	3300	1,21	0,70	0,18	2900	70		8
HCT 31-2M	3336	1,42		0,18	2900	70		8
HCT 31-4T	1584	0,65	0,38	0,09	1550	52		8
HCT 31-4M	1656	0,65		0,10	1550	52		8
HCH HCT 35-2T	3252	1,92	1,11	0,37	5750	77	9	12
HCT 35-2M	3336	2,53		0,37	5750	77		12
HCH HCT 35-4T	1584	0,65	0,38	0,09	3100	59	7	10
HCT 35-4M	1656	0,65		0,10	3100	59		10
HCH HCT 40-2T-1,5	3432	4,20	2,40	1,10	8800	84	17	25
HCH HCT 40-4T-0,33	1620	1,66	0,96	0,25	5150	64	13	21
HCT 45-2T-2	3324	5,44	3,13	1,50	10650	86		31
HCT 45-2T-3	3462	7,77	4,47	2,20	12750	88		34
HCT 45-2/4T-3	3492 / 1704		5,00 / 1,60	2,20 / 0,60	12750/6375	88/73		33
HCH HCT 45-4T-0,5	1644	2,02	1,17	0,37	7100	68	15	24
HCH HCT 45-4M-0,5	1680	2,76		0,37	7100	68	15	24
HCH 45-6T-0,33	1080	1,51	0,87	0,25	4750	55	14	
HCH 45-6M-0,33	1140	1,30		0,25	4750	55	15	
HCT 50-4T-0,75	1656	2,92	1,69	0,55	10400	70		28
HCH HCT 56-4T-0,75	1656	2,92	1,69	0,55	11050	72	21	33
HCH HCT 56-4M-0,75	1740	4,40		0,55	11050	72	21	33

### Características técnicas

Modelo	Velocidad (r/min)	Intensidad máxima admisible (A)		Potencia instalada (kW)	Caudal máximo (m³/h)	Nivel presión sonora dB(A)	Peso aprox.	
		220-277V	380-480V				HCH	HCT
HCH HCT 56-4T-1	1692	3,10	1,79	0,75	12950	73	22	34
HCH HCT 56-4/8T-1	1716 / 852		2,00 / 0,90	0,75 / 0,20	12950/6475	73/58	23	35
HCH HCT 56-4T-1,5	1680	4,03	2,32	1,10	14000	74	26	37
HCH HCT 56-4/8T-1,5	1728 / 852		2,90 / 1,30	1,10 / 0,25	14000/7000	74/59	24	35
HCH HCT 56-4T-2	1716	5,96	3,44	1,50	15300	75	28	39
HCH HCT 56-4/8T-2	1704 / 840		3,50 / 1,50	1,50 / 0,37	15300/7650	75/60	28	39
HCH HCT 56-6T-0,33	1080	1,51	0,87	0,25	8500	61	18	30
HCH HCT 56-6M-0,33	1140	1,85		0,25	8400	61	19	31
HCH HCT 56-6T-0,5	1080	2,24	1,30	0,37	9300	61	20	32
HCH HCT 56-6T-0,75	1080	2,99	1,73	0,55	10000	62	22	34
HCH HCT 63-4T-1	1692	3,10	1,79	0,75	14150	73	27	42
HCH HCT 63-4/8T-1	1716 / 852		2,00 / 0,90	0,75 / 0,20	14150/7075	73/58	27	43
HCH HCT 63-4T-1,5	1680	4,03	2,32	1,10	17000	74	30	45
HCH HCT 63-4/8T-1,5	1728 / 852		2,90 / 1,30	1,10 / 0,25	17000/8500	74/59	29	44
HCH HCT 63-4T-2	1716	5,96	3,44	1,50	18900	75	33	48
HCH HCT 63-4/8T-2	1704 / 840		3,50 / 1,50	1,50 / 0,37	18900/9450	75/60	32	48
HCH HCT 63-4T-3	1734	8,36	4,83	2,20	22100	76	41	57
HCH HCT 63-4/8T-3	1716 / 852		4,90 / 1,70	2,20 / 0,45	22100/11050	76/61	38	54
HCH HCT 63-4T-4	1734	10,96	6,33	3,00	25400	77	43	59
HCH HCT 63-4/8T-4	1716 / 852		6,50 / 2,30	3,00 / 0,60	25400/12700	77/62	42	57
HCH HCT 63-6T-0,5	1080	2,24	1,30	0,37	12150	64	25	40
HCH HCT 63-6M-0,5	1080	2,69		0,37	12150	64	25	40
HCH HCT 63-6T-0,75	1080	2,99	1,73	0,55	12750	65	27	42
HCH HCT 63-6T-1	1134	3,90	2,20	0,75	13800	66	33	48
HCH HCT 63-6/12T-1	1122 / 522		2,20 / 0,87	0,75 / 0,15	13800/6900	66/51	32	47
HCH HCT 71-4T-1,5	1680	4,03	2,32	1,10	19750	78	33	52
HCH HCT 71-4/8T-1,5	1728 / 852		2,90 / 1,30	1,10 / 0,25	19600/9800	78/63	32	51
HCH HCT 71-4T-2	1716	5,96	3,44	1,50	21100	79	36	55
HCH HCT 71-4/8T-2	1704 / 840		3,50 / 1,50	1,50 / 0,37	21100/10550	79/64	35	54
HCH HCT 71-4T-3	1734	8,36	4,83	2,20	23950	81	45	64
HCH HCT 71-4/8T-3	1716 / 852		4,90 / 1,70	2,20 / 0,45	24150/12075	81/66	42	61
HCH HCT 71-4T-4	1734	10,96	6,33	3,00	29400	82	47	66
HCH HCT 71-4/8T-4	1716 / 852		6,50 / 2,30	3,00 / 0,60	29550/14775	82/67	46	64
HCH HCT 71-6T-0,75	1080	2,99	1,73	0,55	15150	67	29	49
HCH HCT 71-6M-0,75	1080	3,84		0,55	15150	67	29	49
HCH HCT 71-6T-1	1134	3,90	2,20	0,75	17250	68	36	55
HCH HCT 71-6/12T-1	1122 / 522		2,20 / 0,87	0,75 / 0,15	17150/8575	68/53	35	54
HCH HCT 71-6T-1,5	1134	4,88	2,82	1,10	20950	69	38	57
HCH HCT 71-6/12T-1,5	1140 / 564		3,00 / 1,15	1,10 / 0,18	20950/10475	69/54	37	56
HCH HCT 80-4T-3	1734	8,36	4,83	2,20	28000	82	53	72
HCH HCT 80-4/8T-3	1716 / 852		4,90 / 1,70	2,20 / 0,45	28000/14000	82/67	50	69
HCH HCT 80-4T-4	1734	10,96	6,33	3,00	32700	83	55	74
HCH HCT 80-4/8T-4	1716 / 852		6,50 / 2,30	3,00 / 0,60	32700/16350	83/68	54	73
HCH HCT 80-4T-5,5	1728	14,10	8,12	4,00	37200	84	60	79
HCH HCT 80-4/8T-5,5	1716 / 852		8,20 / 2,90	4,00 / 0,80	37200/18600	84/69	66	85
HCH HCT 80-6T-1	1134	3,90	2,20	0,75	20600	71	44	64
HCH HCT 80-6/12T-1	1122 / 522		2,20 / 0,87	0,75 / 0,15	20600/10300	71/56	43	63
HCH HCT 80-6T-1,5	1134	4,88	2,82	1,10	24250	72	46	66
HCH HCT 80-6/12T-1,5	1140 / 564		3,00 / 1,15	1,10 / 0,18	24250/12125	72/57	45	65
HCH HCT 80-6T-2	1146	6,42	3,71	1,50	28000	73	52	71
HCH HCT 80-6/12T-2	1164 / 564		4,60 / 1,90	1,50 / 0,25	28000/14000	73/58	62	81
HCH HCT 80-6T-3	1146	9,30	5,30	2,20	32500	74	57	76
HCH HCT 80-6/12T-3	1128 / 564		5,60 / 2,20	2,20 / 0,37	32500/16250	74/59	62	81
HCH HCT 80-8T-0,5	840	2,77	1,60	0,37	16600	69	43	63
HCH HCT 80-8T-0,75	834	3,53	2,04	0,55	19600	70	45	65
HCH HCT 80-8T-1	846	4,68	2,70	0,75	22150	71	50	69
HCH HCT 90-4T-4	1734	10,96	6,33	3,00	37750	87	62	90
HCH HCT 90-4/8T-4	1716 / 852		6,50 / 2,30	3,00 / 0,60	37750/18875	87/72	61	88
HCH HCT 90-4T-5,5	1728	14,10	8,12	4,00	41850	89	67	95
HCH HCT 90-4/8T-5,5	1716 / 852		8,20 / 2,90	4,00 / 0,80	41850/20925	89/74	73	101
HCH HCT 90-4T-7,5	1728		11,60	5,50	47000	91	83	109
HCH HCT 90-4/8T-7,5	1740 / 864		11,80 / 3,80	5,50 / 1,10	47000/23500	91/76	93	119
HCH HCT 90-4T-10	1746		14,20	7,50	53000	92	94	120
HCH HCT 90-4T-10	1758		13,90	7,50	53000	92	110	136
HCH HCT 90-4/8T-10	1752 / 870		15,30 / 5,40	7,50 / 1,50	53000/26500	92/77	98	124
HCH HCT 90-6T-2	1146	6,42	3,71	1,50	30000	77	59	87
HCH HCT 90-6/12T-2	1164 / 564		4,60 / 1,90	1,50 / 0,25	30000/15000	77/62	69	97

**Características técnicas**

Modelo	Velocidad (r/min)	Intensidad máxima admisible (A)		Potencia instalada (kW)	Caudal máximo (m³/h)	Nivel presión sonora dB(A)	Peso aprox.	
		220-277V	380-480V				HCH	HCT
HCH HCT 90-6T-3	1146	11,46	5,30	2,20	35000	78	64	92
HCH HCT 90-6/12T-3	1128 / 564		5,60 / 2,20	2,20 / 0,37	35000/17500	78/63	69	97
HCH HCT 90-6T-4	1152	12,70	7,30	3,00	40000	79	88	114
HCH HCT 90-6/12T-4	1152 / 576		9,00 / 3,50	3,00 / 0,55	40000/20000	79/64	87	113
HCH HCT 90-8T-1	846	4,68	2,70	0,75	22400	71	57	85
HCH HCT 90-8T-1,5	846	5,63	3,25	1,10	24150	72	60	88
HCH HCT 90-8T-2	846	7,10	4,10	1,50	26300	73	71	99
HCH HCT 90-8T-3	846	9,53	5,50	2,20	30150	74	98	124
HCH HCT 100-4T-7,5	1728		11,60	5,50	52500	92	91	121
HCH HCT 100-4/8T-7,5	1740 / 864		11,80 / 3,80	5,50 / 1,10	52500/26250	92/77	101	128
HCH HCT 100-4T-10	1746		14,20	7,50	58500	93	102	131
HCH HCT 100-4T-10	1758		13,90	7,50	58500	93	118	147
HCH HCT 100-4/8T-10	1752 / 870		15,30 / 5,40	7,50 / 1,50	58500/29250	93/78	106	135
HCH HCT 100-4T-15	1752		20,20	11,00	68000	94	125	160
HCH HCT 100-4T-15	1764		20,90	11,00	68000	94	150	185
HCH HCT 100-4/8T-15	1764 / 870		23,20 / 8,70	11,00 / 2,80	68000/34000	94/79	125	160
HCH HCT 100-4T-20	1752		27,50	15,00	71850	95	144	179
HCH HCT 100-4T-20	1758		27,90	15,00	71850	95	161	196
HCH HCT 100-4/8T-20	1752 / 870		31,72 / 11,75	15,00 / 3,80	72450/36225	95/80	140	175
HCH HCT 100-6T-3	1146	9,30	5,30	2,20	40500	82	72	103
HCH HCT 100-6/12T-3	1128 / 564		5,60 / 2,20	2,20 / 0,37	40500/20250	82/67	77	108
HCH HCT 100-6T-4	1152	12,70	7,30	3,00	46950	83	96	125
HCH HCT 100-6/12T-4	1152 / 576		9,00 / 3,50	3,00 / 0,55	46950/23475	83/68	95	124
HCH HCT 100-6T-5,5	1152	16,50	9,46	4,00	52000	84	104	133
HCH HCT 100-6/12T-5,5	1164 / 576		4,00 / 11,00	4,00 / 0,65	52000/26000	84/69	100	129
HCH HCT 100-8T-1,5	846	5,63	3,25	1,10	32500	76	67	99
HCH HCT 100-8T-2	846	7,10	4,10	1,50	33850	77	79	110
HCH HCT 100-8T-3	846	9,53	5,50	2,20	35150	77	106	135
HCH HCT 100-8T-4	846	12,82	7,40	3,00	37800	78	114	143

**Características acústicas**

Los valores indicados, se determinan mediante medidas de nivel de presión y potencia sonora en dB(A) obtenidas en campo libre a una distancia equivalente a dos veces la envergadura del ventilador más el diámetro de la hélice, con un mínimo de 1,5 mts.

Espectro de potencia sonora Lw(A) en dB(A) por banda de frecuencia en Hz

Modelo	63	125	250	500	1000	2000	4000	8000	Modelo	63	125	250	500	1000	2000	4000	8000
25-2	35	50	69	68	69	68	63	54	71-4-1,5	55	75	83	88	90	87	80	69
25-4	21	36	55	54	55	54	49	40	71-8-1,5 (2v)	40	60	68	73	75	72	65	54
31-2	41	56	75	74	75	74	69	60	71-4-2	56	76	84	89	91	88	81	70
31-4	23	38	57	56	57	56	51	42	71-8-2 (2v)	41	61	69	74	76	73	66	55
35-2	48	63	82	81	82	81	76	67	71-4-3	58	78	86	91	93	90	83	72
35-4	30	45	64	63	64	63	58	49	71-8-3 (2v)	43	63	71	76	78	75	68	57
40-2	55	70	89	88	89	88	83	74	71-4-4	59	79	87	92	94	91	84	73
40-4	35	50	69	68	69	68	63	54	71-8-4 (2v)	44	64	72	77	79	76	69	58
45-2-2	51	68	80	88	93	93	89	82	71-6-0,75	44	64	72	77	79	76	69	58
45-2-3	53	70	82	90	95	95	91	84	71-6-1	45	65	73	78	80	77	70	59
45-4-3 (2v)	38	55	67	75	80	80	76	69	71-12-1 (2v)	30	50	58	63	65	62	55	44
45-4-0,5	33	50	62	70	75	75	71	64	71-6-1,5	46	66	74	79	81	78	71	60
45-6	20	37	49	57	62	62	58	51	71-12-1,5 (2v)	31	51	59	64	66	63	56	45
50-4	37	54	67	74	79	80	75	68	80-4-3	59	79	87	92	94	91	84	73
56-4-0,75	47	67	75	80	82	79	72	61	80-8-3 (2v)	44	64	72	77	79	76	69	58
56-4-1	48	68	76	81	83	80	73	62	80-4-4	60	80	88	93	95	92	85	74
56-8-1 (2v)	33	53	61	66	68	65	58	47	80-8-4 (2v)	45	65	73	78	80	77	70	59
56-4-1,5	49	69	77	82	84	81	74	63	80-4-5,5	61	81	89	94	96	93	86	75
56-8-1,5 (2v)	34	54	62	67	69	66	59	48	80-8-5,5 (2v)	46	66	74	79	81	78	71	60
56-4-2	50	70	78	83	85	82	75	64	80-6-1	48	68	76	81	83	80	73	62
56-8-2 (2v)	35	55	63	68	70	67	60	49	80-12-1 (2v)	33	53	61	66	68	65	58	47
56-6-0,33	36	56	64	69	71	68	61	50	80-6-1,5	49	69	77	82	84	81	74	63
56-6-0,5	36	56	64	69	71	68	61	50	80-12-1,5 (2v)	34	54	62	67	69	66	59	48
56-6-0,75	37	57	65	70	72	69	62	51	80-6-2	50	70	78	83	85	82	75	64
63-4-1	50	70	78	83	85	82	75	64	80-12-2 (2v)	35	55	63	68	70	67	60	49
63-8-1 (2v)	35	55	63	68	70	67	60	49	80-6-3	51	71	79	84	86	83	76	65
63-4-1,5	51	71	79	84	86	83	76	65	80-12-3 (2v)	36	56	64	69	71	68	61	50
63-8-1,5 (2v)	36	56	64	69	71	68	61	50	80-8-0,5	46	66	74	79	81	78	71	60
63-4-2	52	72	80	85	87	84	77	66	80-8-0,75	47	67	75	80	82	79	72	61
63-8-2 (2v)	37	57	65	70	72	69	62	51	80-8-1	48	68	76	81	83	80	73	62
63-4-3	53	73	81	86	88	85	78	67	90-4-4	65	86	93	98	101	97	90	79
63-8-3 (2v)	38	58	66	71	73	70	63	52	90-8-4 (2v)	50	71	78	83	86	82	75	64
63-4-4	54	74	82	87	89	86	79	68	90-4-5,5	67	88	95	100	103	99	92	81
63-8-4 (2v)	39	59	67	72	74	71	64	53	90-8-5,5 (2v)	52	73	80	85	88	84	77	66
63-6-0,5	41	61	69	74	76	73	66	55	90-4-7,5	69	90	97	102	105	101	94	83
63-6-0,75	42	62	70	75	77	74	67	56	90-8-7,5 (2v)	54	75	82	87	90	86	79	68
63-6-1	43	63	71	76	78	75	68	57	90-4-10	70	91	98	103	106	102	95	84
63-12-1 (2v)	28	48	56	61	63	60	53	42	90-8-10 (2v)	55	76	83	88	91	87	80	69

## Características acústicas

Los valores indicados, se determinan mediante medidas de nivel de presión y potencia sonora en dB(A) obtenidas en campo libre a una distancia equivalente a dos veces la envergadura del ventilador más el diámetro de la hélice, con un mínimo de 1,5 mts.

Espectro de potencia sonora Lw(A) en dB(A) por banda de frecuencia en Hz

Modelo	63	125	250	500	1000	2000	4000	8000	Modelo	63	125	250	500	1000	2000	4000	8000
90-6-2	55	76	83	88	91	87	80	69	100-4-15	74	94	102	107	109	106	99	88
90-12-2 (2v)	40	61	68	73	76	72	65	54	100-8-15 (2v)	59	79	87	92	94	91	84	73
90-6-3	56	77	84	89	92	88	81	70	100-4-20	75	95	103	108	110	107	100	89
90-12-3 (2v)	41	62	69	74	77	73	66	55	100-8-20 (2v)	60	80	88	93	95	92	85	74
90-6-4	57	78	85	90	93	89	82	71	100-6-3	62	82	90	95	97	94	87	76
90-12-4 (2v)	42	63	70	75	78	74	67	56	100-12-3 (2v)	47	67	75	80	82	79	72	61
90-8-1	49	70	77	82	85	81	74	63	100-6-4	63	83	91	96	98	95	88	77
90-8-1,5	50	71	78	83	86	82	75	64	100-12-4 (2v)	48	68	76	81	83	80	73	62
90-8-2	51	72	79	84	87	83	76	65	100-6-5,5	64	84	92	97	99	96	89	78
90-8-3	52	73	80	85	88	84	77	66	100-12-5,5 (2v)	49	69	77	82	84	81	74	63
100-4-7,5	72	92	100	105	107	104	97	86	100-8-1,5	56	76	84	89	91	88	81	70
100-8-7,5 (2v)	57	77	85	90	92	89	82	71	100-8-2	57	77	85	90	92	89	82	71
100-4-10	73	93	101	106	108	105	98	87	100-8-3	57	77	85	90	92	89	82	71
100-8-10 (2v)	58	78	86	91	93	90	83	72	100-8-4	58	78	86	91	93	90	83	72

## Dimensiones mm

HCH

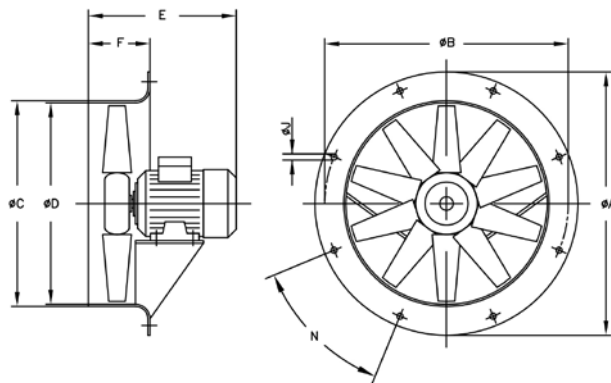

Modelo	ØA	ØB	ØC	ØD	E																F	ØJ	N
					0.16	0.33	0.5	0.75	1	1.5	2	3	4	5.5	7.5	10	15	20					
HCH-35-2	425	395	358	355	-	-	285	-	-	-	-	-	-	-	-	-	-	-	110	10	8x45°		
HCH-35-4	425	395	358	355	257	-	-	-	-	-	-	-	-	-	-	-	-	-	110	10	8x45°		
HCH-40-2	490	450	414	410	-	-	-	-	314	-	-	-	-	-	-	-	-	-	120	12	8x45°		
HCH-40-4	490	450	414	410	-	305	-	-	-	-	-	-	-	-	-	-	-	-	120	12	8x45°		
HCH-45-4	540	500	464	460	-	-	295	-	-	-	-	-	-	-	-	-	-	-	120	12	8x45°		
HCH-45-6	540	500	464	460	-	295	-	-	-	-	-	-	-	-	-	-	-	-	120	12	8x45°		
HCH-56-4	660	620	564	560	-	-	-	316	316	330	354	-	-	-	-	-	-	-	120	12	12x30°		
HCH-56-6	660	620	564	560	-	298	316	316	-	-	-	-	-	-	-	-	-	-	120	12	12x30°		
HCH-63-4	730	690	645	640	-	-	-	-	332	340	366	420	420	-	-	-	-	-	150	12	12x30°		
HCH-63-6	730	690	645	640	-	-	332	332	340	-	-	-	-	-	-	-	-	-	150	12	12x30°		
HCH-71-4	810	770	715	710	-	-	-	-	-	334	360	430	430	-	-	-	-	-	150	12	16x22°30'		
HCH-71-6	810	770	715	710	-	-	-	323	334	360	-	-	-	-	-	-	-	-	150	12	16x22°30'		
HCH-80-4	900	860	805	800	-	-	-	-	-	-	-	425	425	445	-	-	-	-	180	12	16x22°30'		
HCH-80-6	900	860	805	800	-	-	-	-	360	386	425	445	-	-	-	-	-	-	180	12	16x22°30'		
HCH-80-8	900	860	805	800	-	-	380	386	410	-	-	-	-	-	-	-	-	-	180	12	16x22°30'		
HCH-90-4	1015	970	906	900	-	-	-	-	-	-	-	436	430	465	465	-	-	-	180	12	16x22°30'		
HCH-90-6	1015	970	906	900	-	-	-	-	-	-	436	430	465	-	-	-	-	-	180	12	16x22°30'		
HCH-90-8	1015	970	906	900	-	-	-	-	436	436	430	460	-	-	-	-	-	-	180	12	16x22°30'		
HCH-100-4	1115	1070	1006	1000	-	-	-	-	-	-	-	-	-	503	503	612	612	200	15	16x22°30'			
HCH-100-6	1115	1070	1006	1000	-	-	-	-	-	-	440	503	503	-	-	-	-	-	200	15	16x22°30'		
HCH-100-8	1115	1070	1006	1000	-	-	-	-	433	440	503	503	-	-	-	-	-	-	200	15	16x22°30'		

Dimensiones mm

HCT

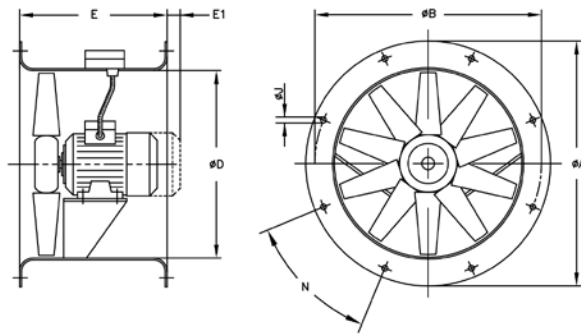

Modelo	ØA	ØB	ØD	E	E1	ØJ	N
HCT-25	310	280	240	230	10	10	4x90°
HCT-31	350	320	280	270	-	10	4x90°
HCT-35	425	395	355	280	-	10	8x45°
HCT-40	490	450	410	320	-	12	8x45°
HCT-45	540	500	460	360	-	12	8x45°
HCT-50	600	560	514	360	-	12	12x30°
HCT-56	660	620	560	400	-	12	12x30°
HCT-63	730	690	640	430	-	12	12x30°
HCT-71	810	770	710	500	-	12	16x22°30'
HCT-80	900	860	800	500	-	12	16x22°30'
HCT-90	1015	970	900	500	-	15	16x22°30'
HCT-100	1115	1070	1000	600	-	15	16x22°30'
HCT-100-4T-15	1115	1070	1000	700	-	15	16x22°30'
HCT-100-4T-20	1115	1070	1000	700	-	15	16x22°30'

Curvas características

Q= Caudal en m³/h, m³/s y cfm.

Pe= Presión estática en mmH₂O, Pa e inwg.

2 Polos=3600 r/min

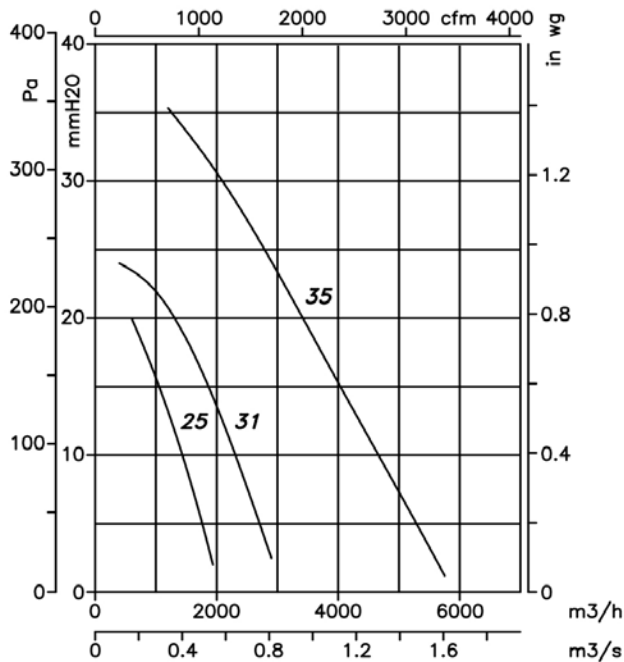

2 Polos=3600 r/min

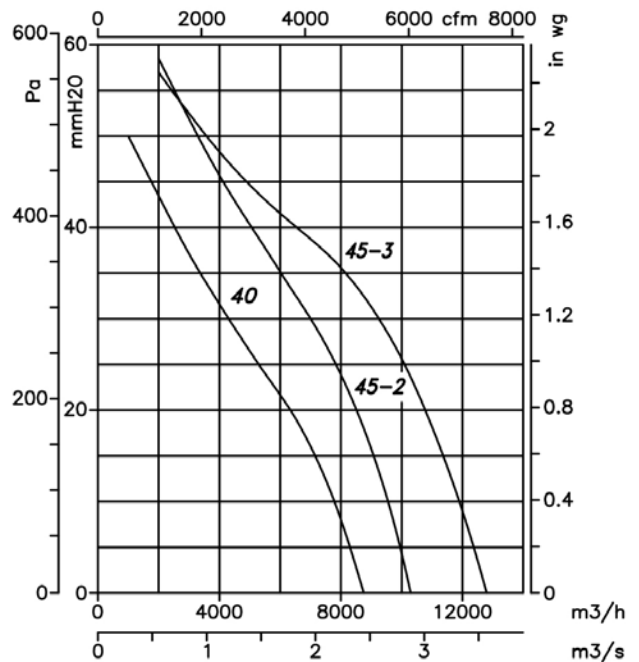

**Curvas características**

Q= Caudal en m<sup>3</sup>/h, m<sup>3</sup>/s y cfm.

Pe= Presión estática en mmH<sub>2</sub>O, Pa e inwg.

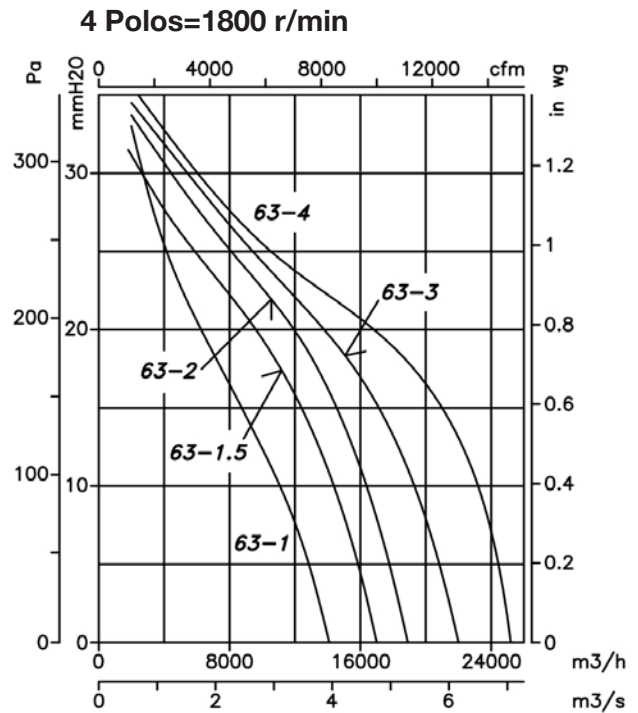
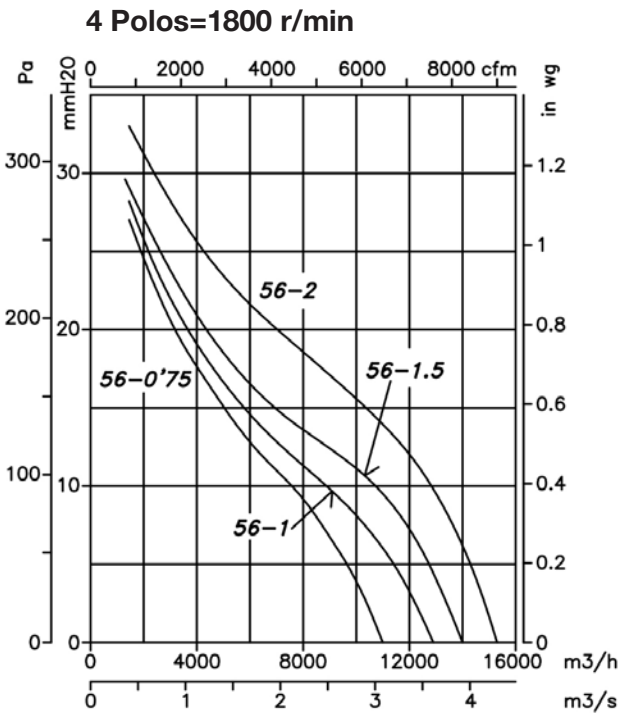
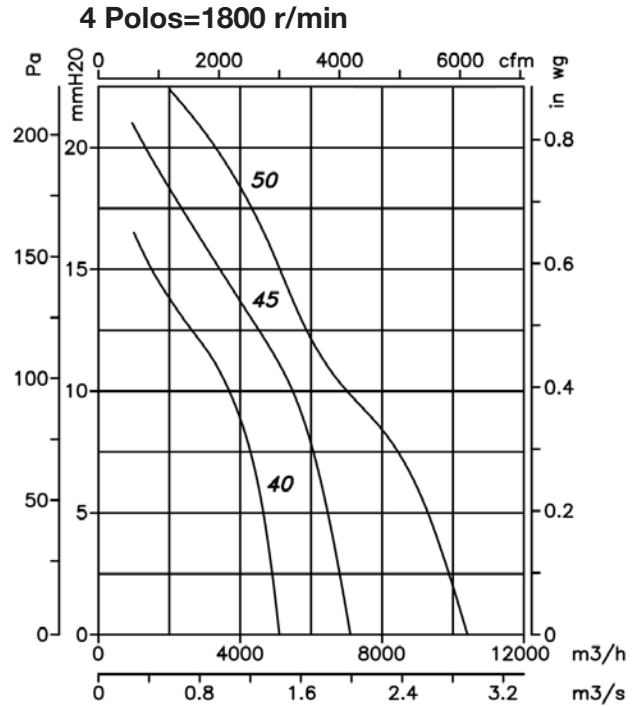
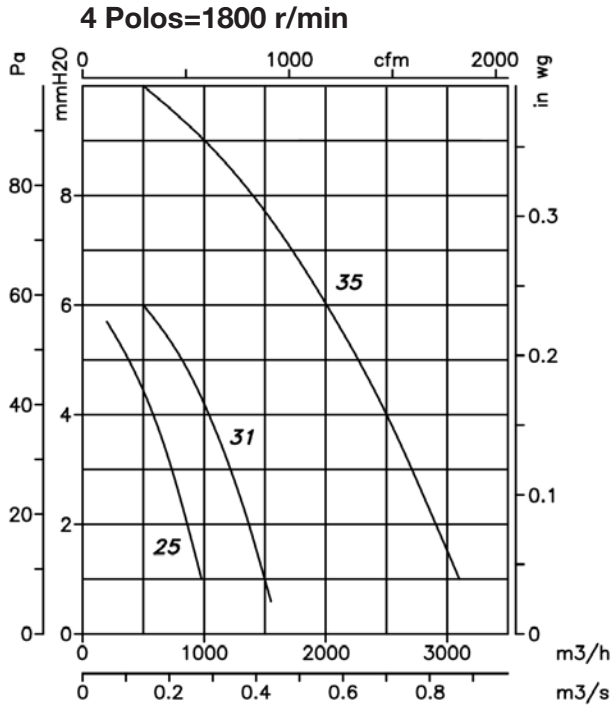

**Curvas características**

Q= Caudal en m<sup>3</sup>/h, m<sup>3</sup>/s y cfm.

Pe= Presión estática en mmH<sub>2</sub>O, Pa e in wg.

**4 Polos=1800 r/min**

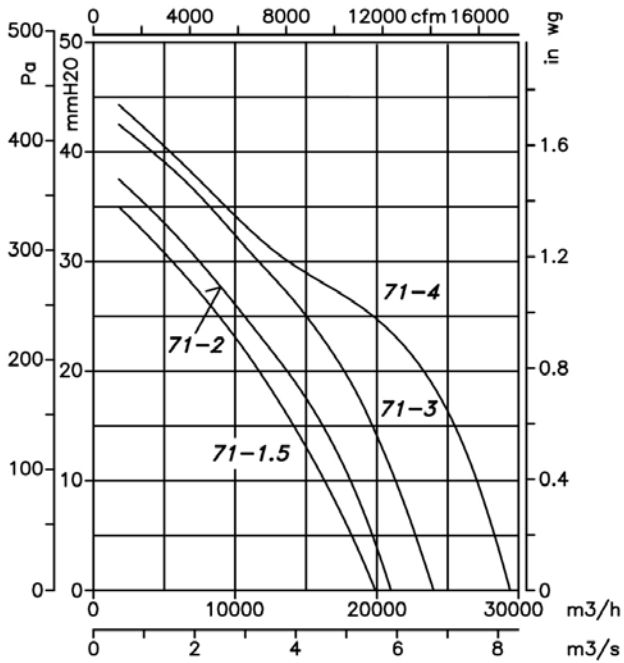

**4 Polos=1800 r/min**

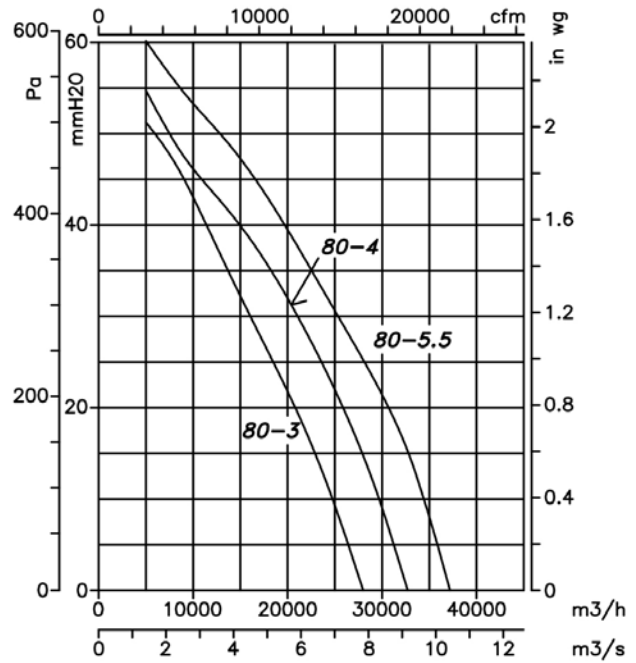

**4 Polos=1800 r/min**

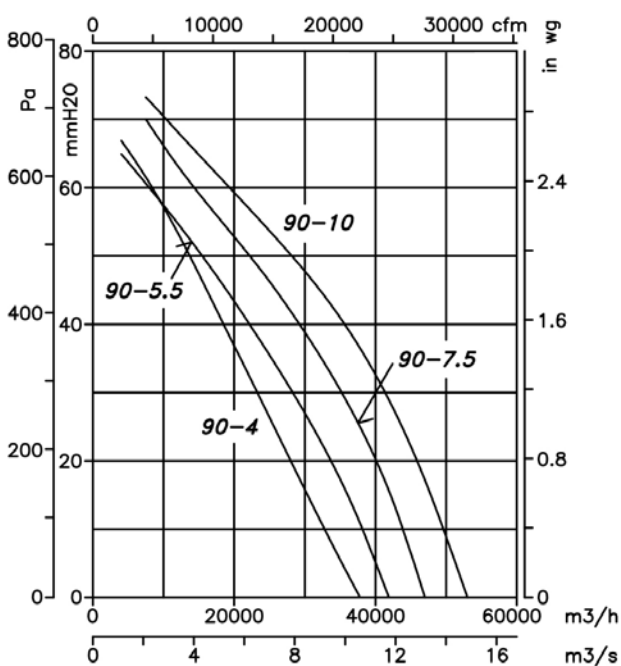

**4 Polos=1800 r/min**

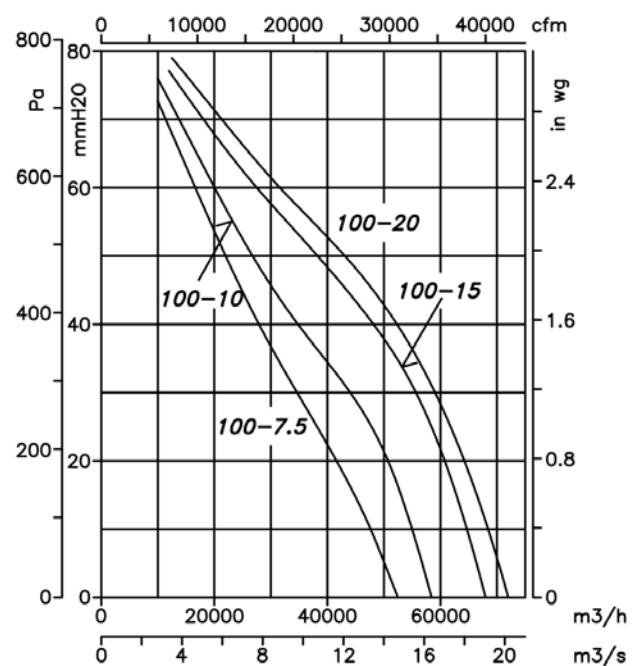

**Curvas características**

Q= Caudal en m<sup>3</sup>/h, m<sup>3</sup>/s y cfm.

Pe= Presión estática en mmH<sub>2</sub>O, Pa e inwg.

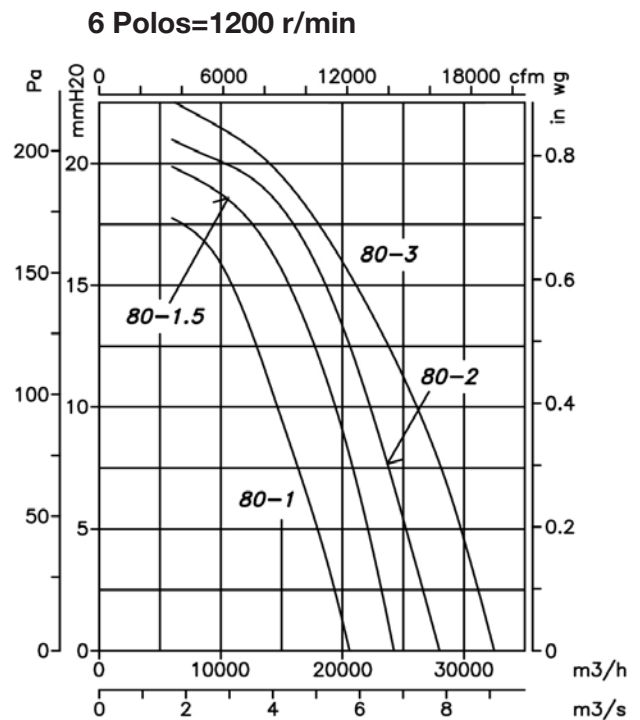
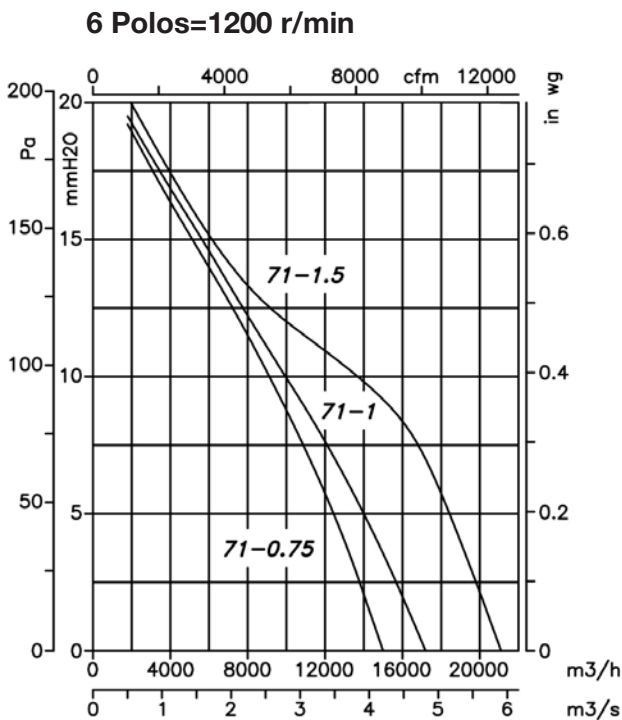
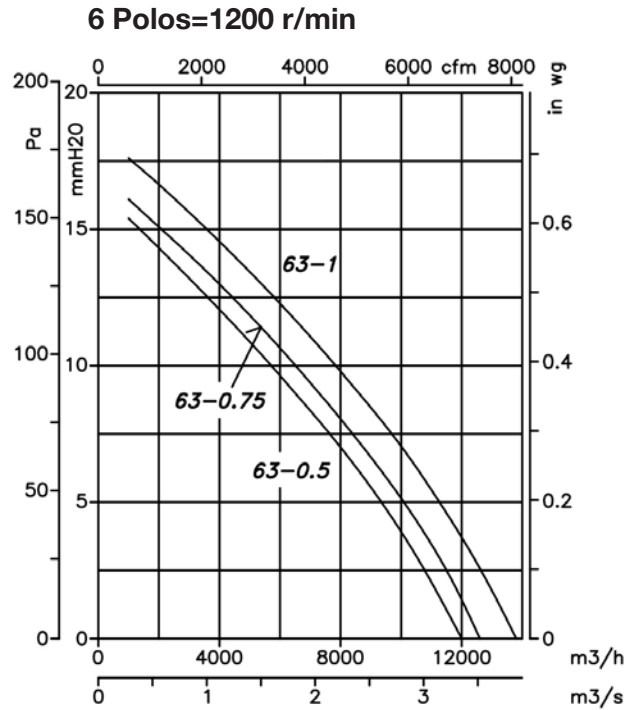
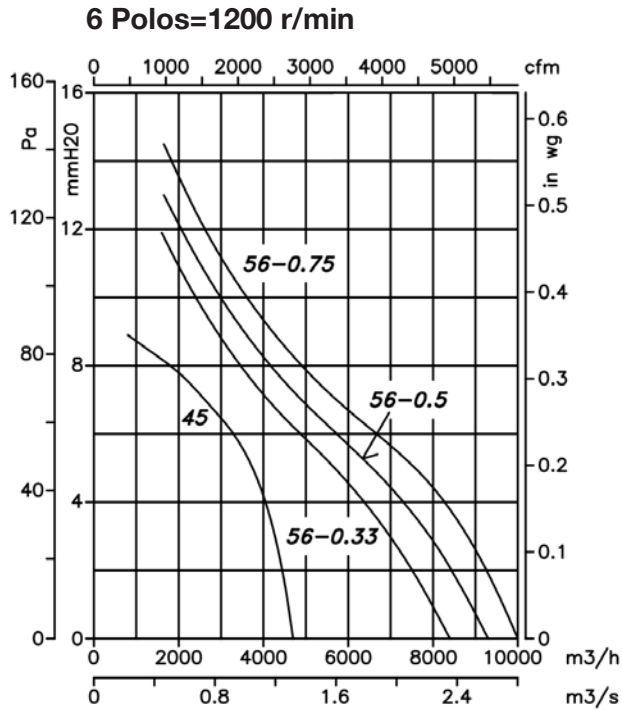



**Curvas características**

Q= Caudal en m<sup>3</sup>/h, m<sup>3</sup>/s y cfm.

Pe= Presión estática en mmH<sub>2</sub>O, Pa e in wg.

**6 Polos=1200 r/min**

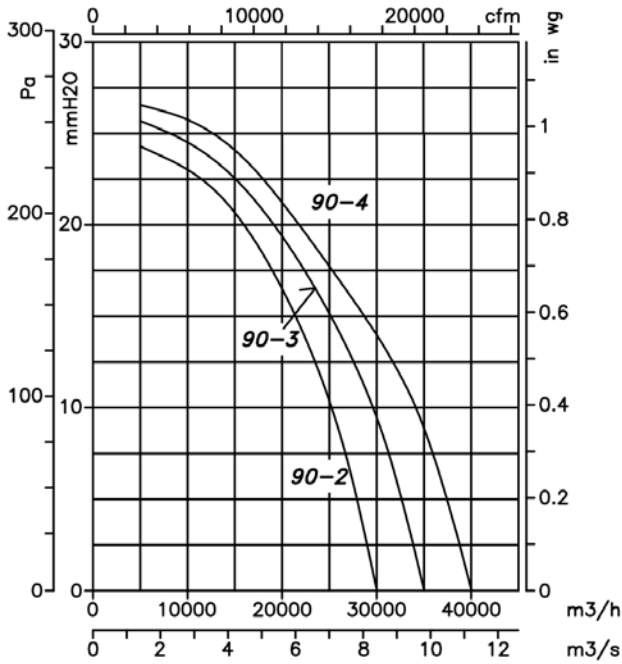

**6 Polos=1200 r/min**

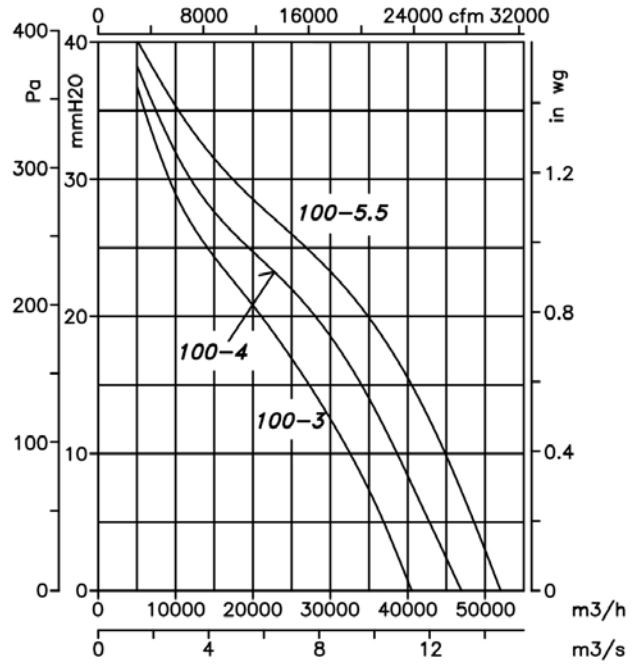

**8 Polos=900 r/min**

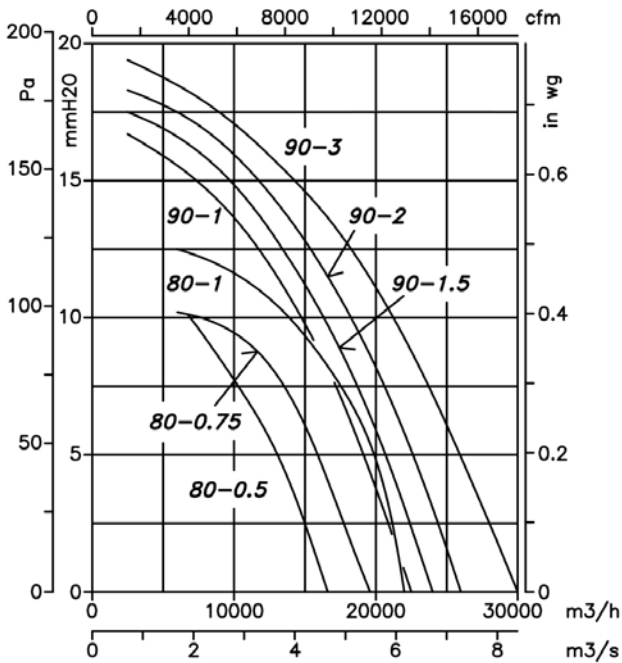

**8 Polos=900 r/min**

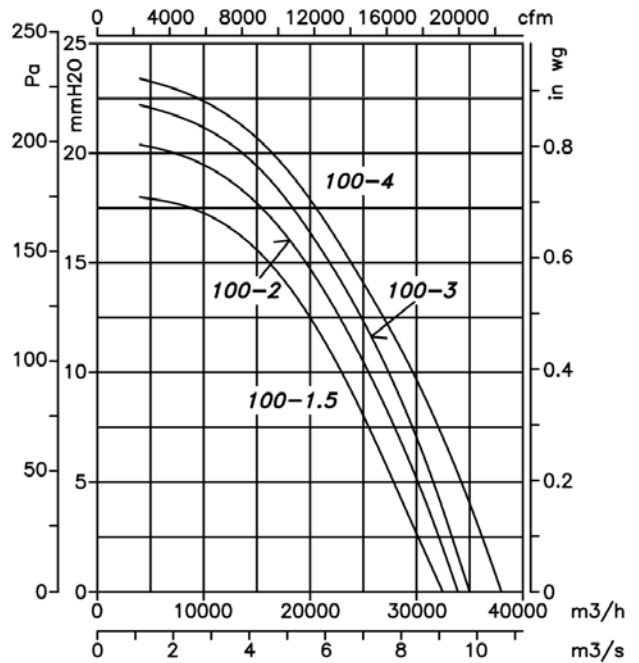

**Curvas características**

Q= Caudal en m<sup>3</sup>/h, m<sup>3</sup>/s y cfm.

Pe= Presión estática en mmH<sub>2</sub>O, Pa e inwg.

**4 Polos (motor 2 vel. 2/4)**

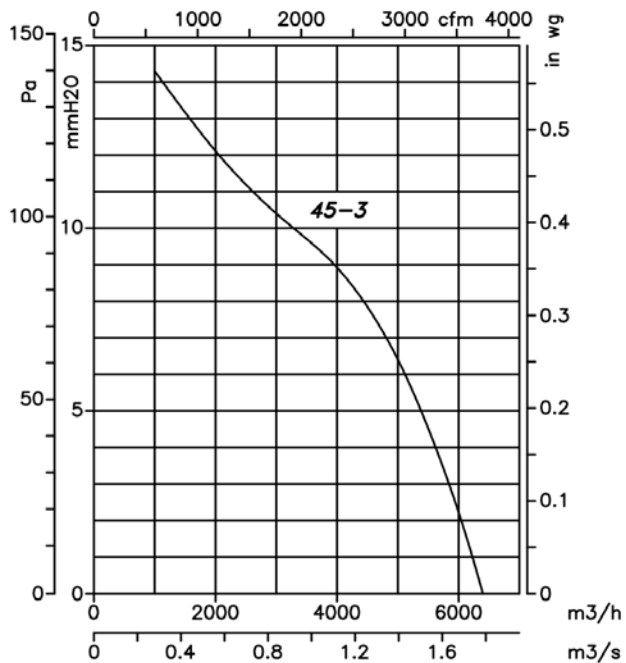

**8 Polos (motor 2 vel. 4/8)**

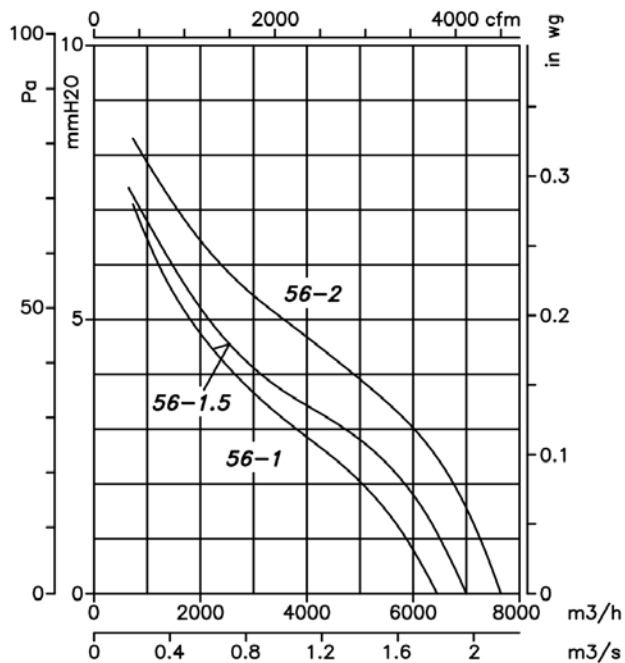

**8 Polos (motor 2 vel. 4/8)**

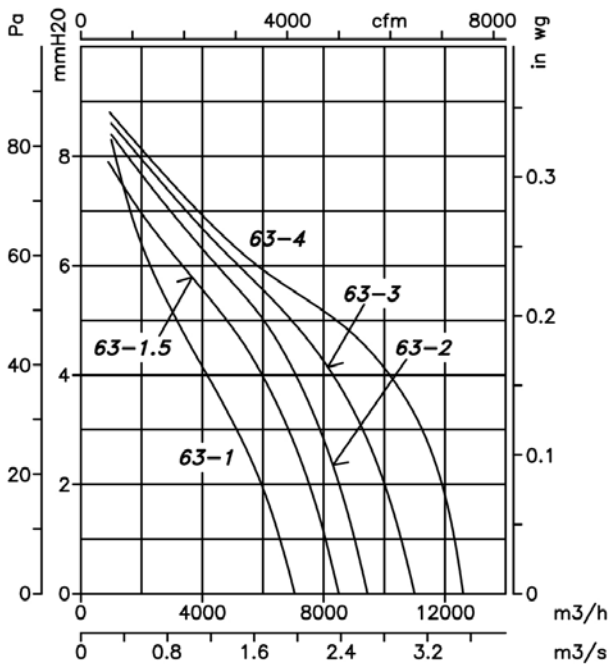

**8 Polos (motor 2 vel. 4/8)**

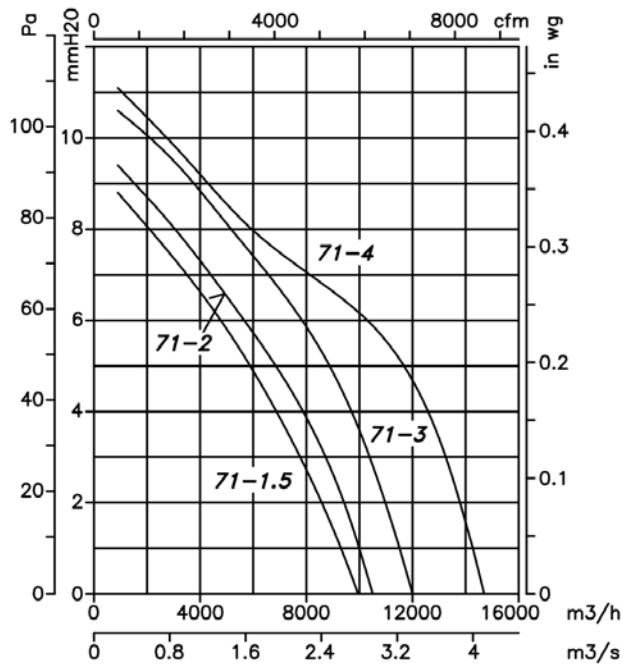

**Curvas características**

Q= Caudal en m<sup>3</sup>/h, m<sup>3</sup>/s y cfm.

Pe= Presión estática en mmH<sub>2</sub>O, Pa e inwg.

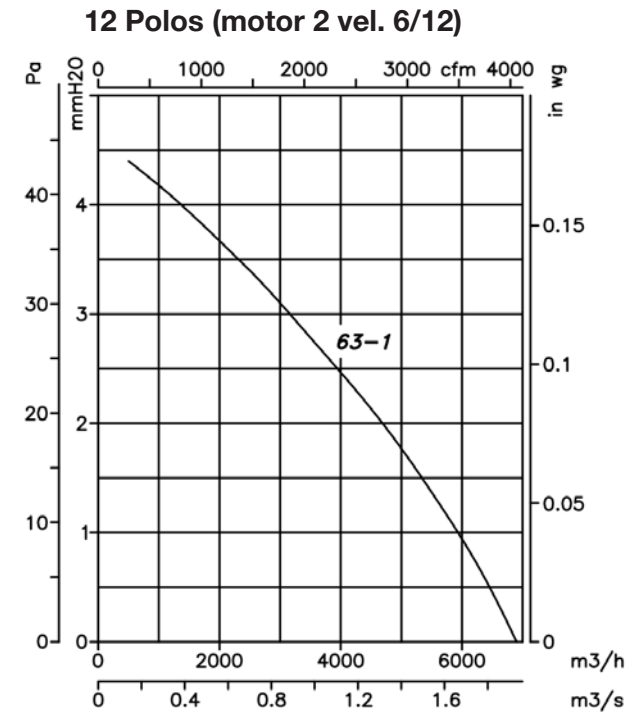
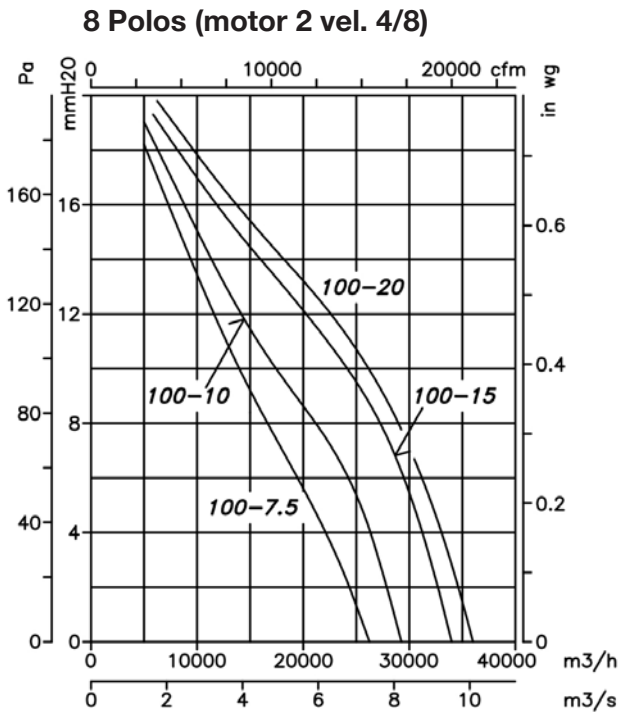
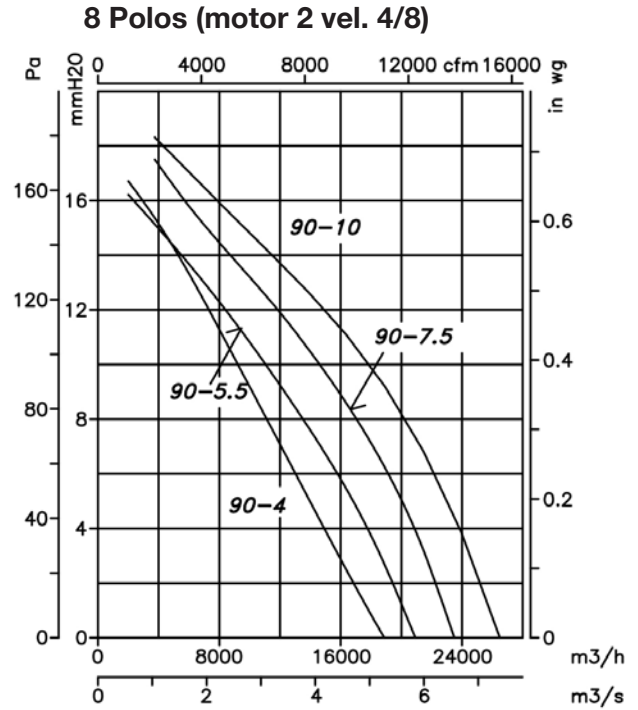
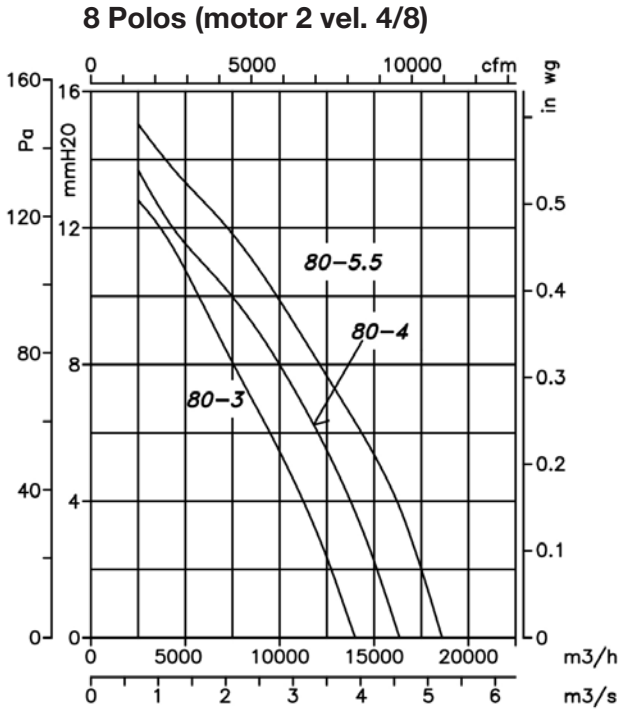

**Curvas características**

Q= Caudal en m<sup>3</sup>/h, m<sup>3</sup>/s y cfm.

Pe= Presión estática en mmH<sub>2</sub>O, Pa e inwg.

**12 Polos (motor 2 vel. 6/12)**

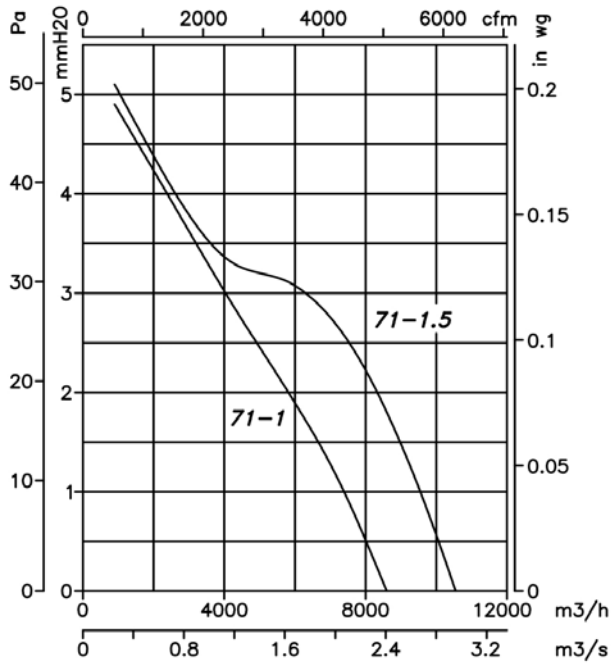

**12 Polos (motor 2 vel. 6/12)**

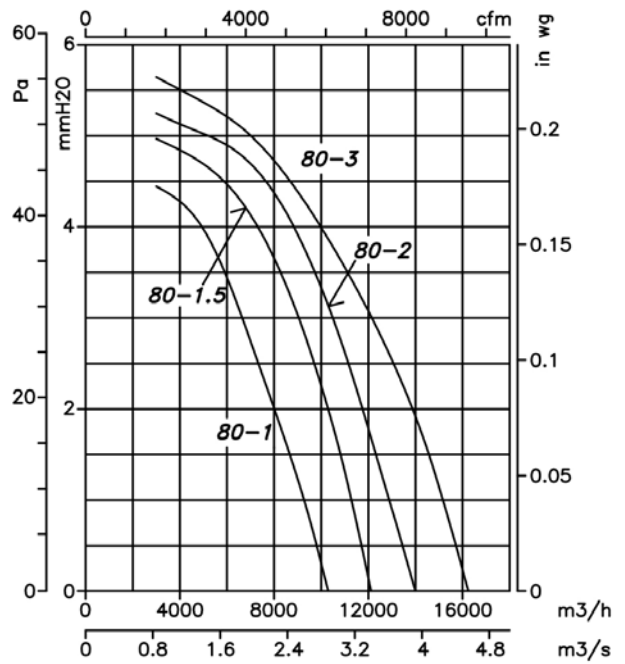

**12 Polos (motor 2 vel. 6/12)**

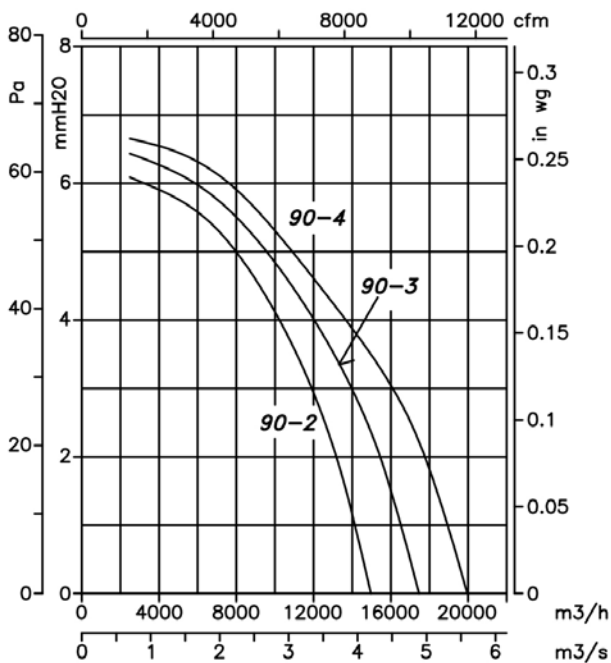

**12 Polos (motor 2 vel. 6/12)**

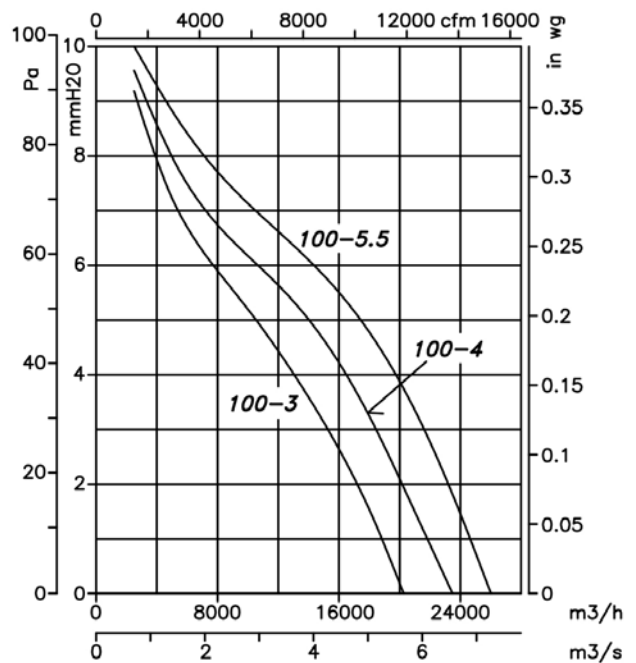

**Accesorios**

